

Precise charged particle timing with the PICOSEC detection concept

Florian M. Brunbauer
on behalf of the PICOSEC collaboration

RD51 PICOSEC-Micromegas Collaboration

CEA Saclay (France): D. Desforge, I. Giomataris, T. Gustavsson, C. Guyot, F.J.Iguaz¹, M. Kebbiri, P. Legou, O. Maillard, T. Papaevangelou, M. Pomorski, P. Schwemlilg, L.Sohl

CERN (Switzerland): J. Bortfeldt, F. Brunbauer, C. David, M. Lisowska, M. Lupberger, H. Müller, E. Oliveri, F. Resnati, L. Ropelewski, T. Schneider, P. Thuiner, M. van Stenis, R. Veenhof², S.White³

USTC (China): J. Liu, B. Qi, X. Wang, Z. Zhang, Y. Zhou

AUTH (Greece): K. Kordas, I. Maniatis, I. Manthos, V. Niaouris, K. Paraschou, D. Sampsonidis, S.E. Tzamarias

NCSR (Greece): G. Fanourakis

NTUA (Greece): Y. Tsipolitis

LIP (Portugal): M. Gallinaro

HIP (Finland): F. García

IGFAE (Spain): D. González-Díaz

1) Now at Synchrotron Soleil, 91192 Gif-sur-Yvette, France

2) Also MEPHl & Uludag University.

3) Also University of Virginia.



Outline

PICOSEC detection concept: precise timing with Micromegas-based detector

Timing studies & detector physics: single photoelectron and MIP beam tests

Towards a robust, large-area detector: resistive Micromegas, photocathodes and scaling-up

Picosecond timing needs

High Luminosity Upgrade of LHC

ATLAS/CMS simulations: ~ 150 vertexes/crossing

To mitigate pile-up and separate particles coming from different vertices:

- 3D tracking of charged particles is not sufficient
- Exploit precise timing to separate tracks

Tens of ps timing + tracking info required

Precise timing detector:

- Tens of ps timing precision
- Large surface coverage
- Resistance against ageing

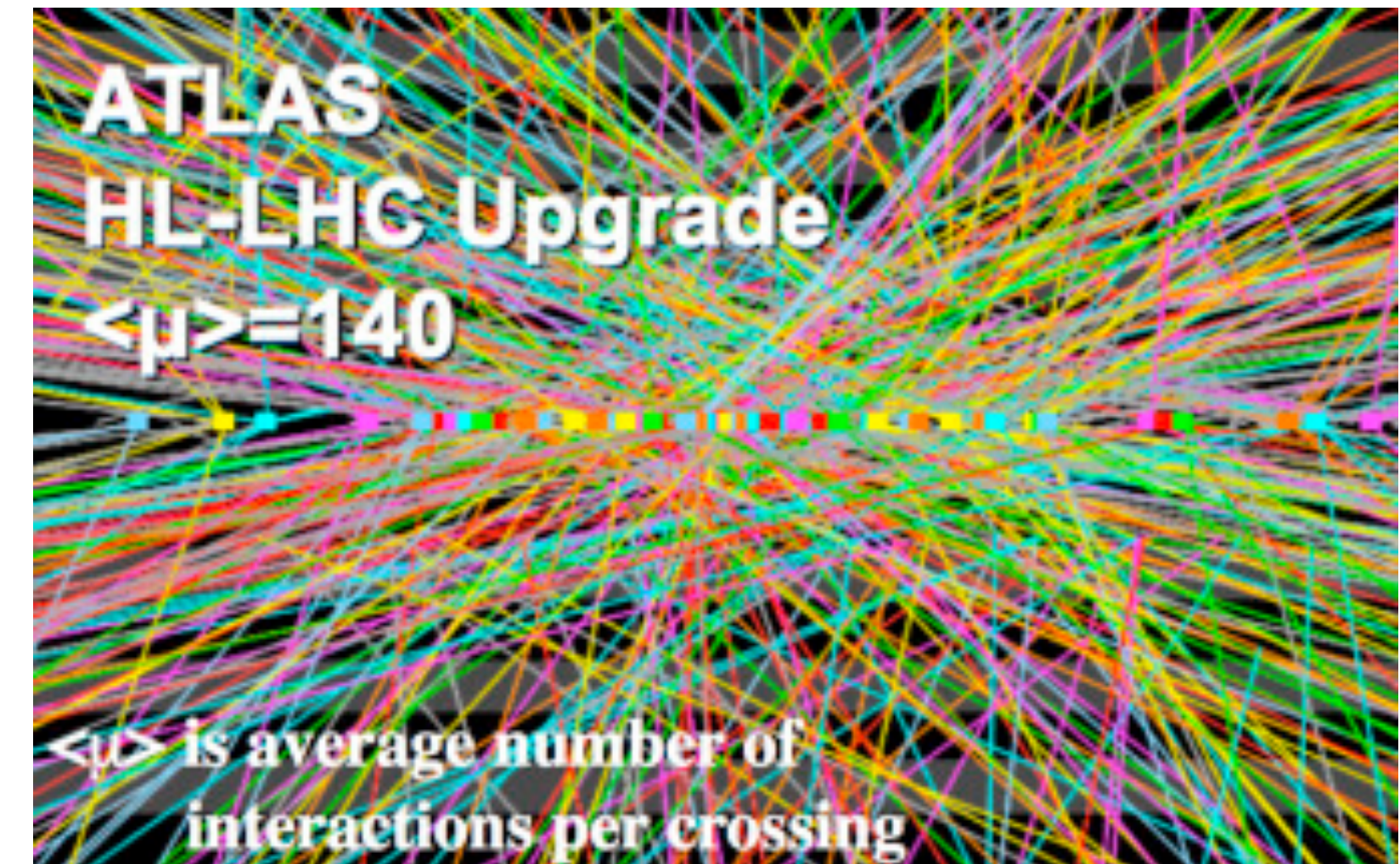

PID techniques: Alternatives to RICH methods, J. Va'vra, NIMA 876 (2017) 185-193, <https://dx.doi.org/10.1016/j.nima.2017.02.075>

Limitations of conventional gaseous detector

Conventional Micromegas:

Giomataris Y. et al., NIMA 376 (1996) 29

Primary electrons produced along trajectory in drift region -> millimetres difference

Timing jitter of \approx ns

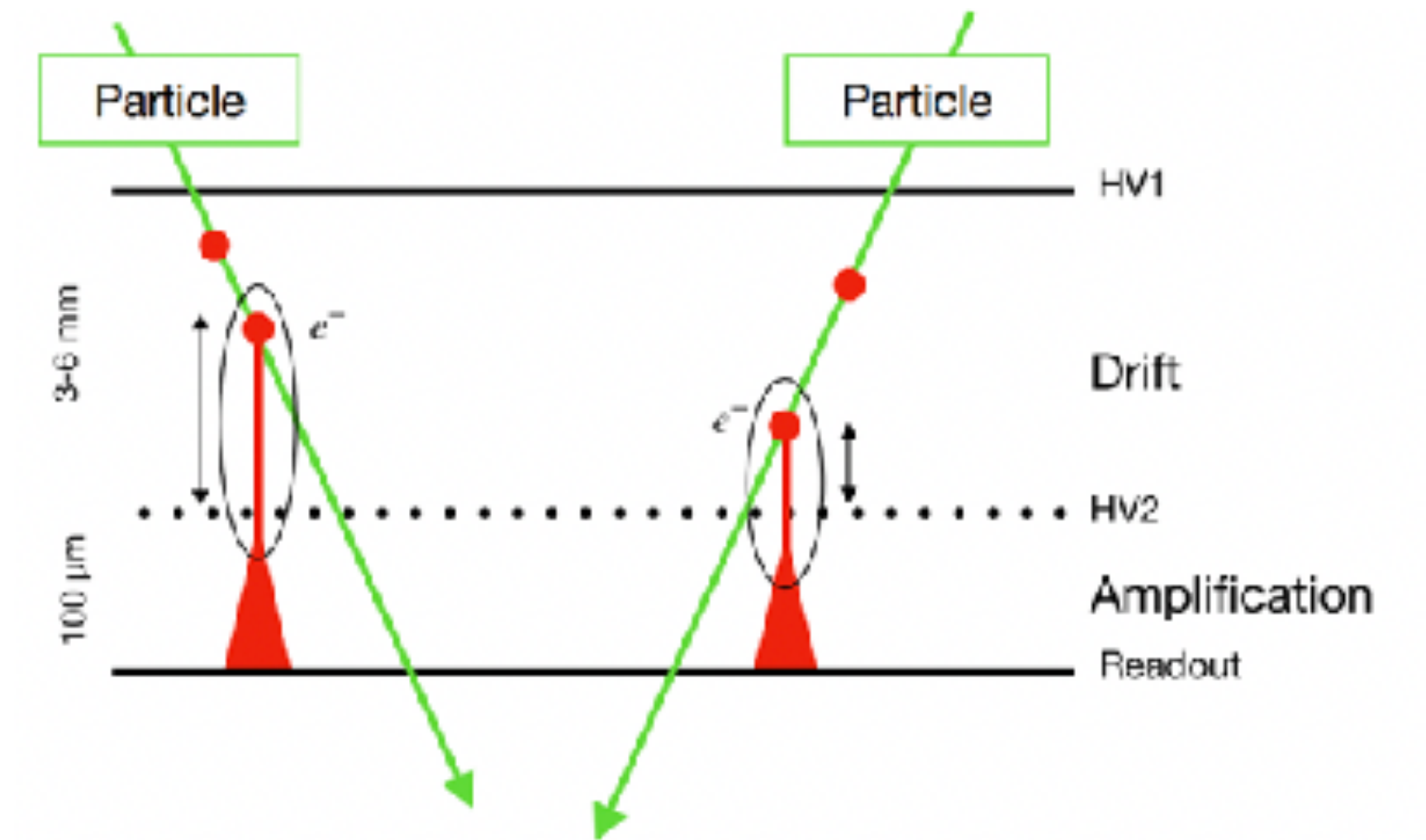

PICOSEC-Micromegas:

<https://doi.org/10.1016/j.nima.2018.04.033>

Cherenkov radiator + Photocathode + Micromegas

Primary electrons at photocathode -> well-defined location

Timing jitter of \approx tens of ps

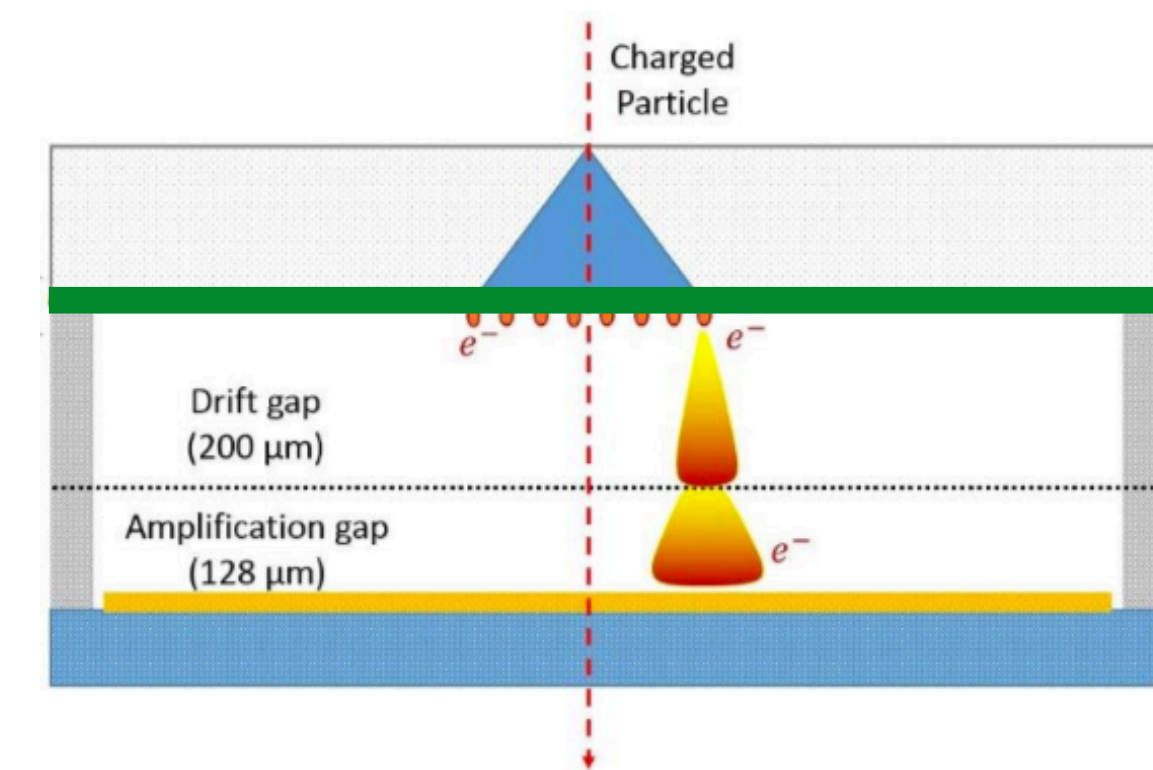

PICOSEC detection concept

Precise timing with Micromegas

PICOSEC: Charged particle timing at sub-25 picosecond precision with a Micromegas based detector

J. Bortfeldt et. al. (RD51-PICOSEC collaboration), Nuclear. Inst. & Methods A 903 (2018) 317-325

Cherenkov radiator
(3 mm MgF₂)

Photocathode
(3 nm Cr + 18 nm CsI)

Drift gap
(Pre-amplification)

Micromegas
(Amplification)

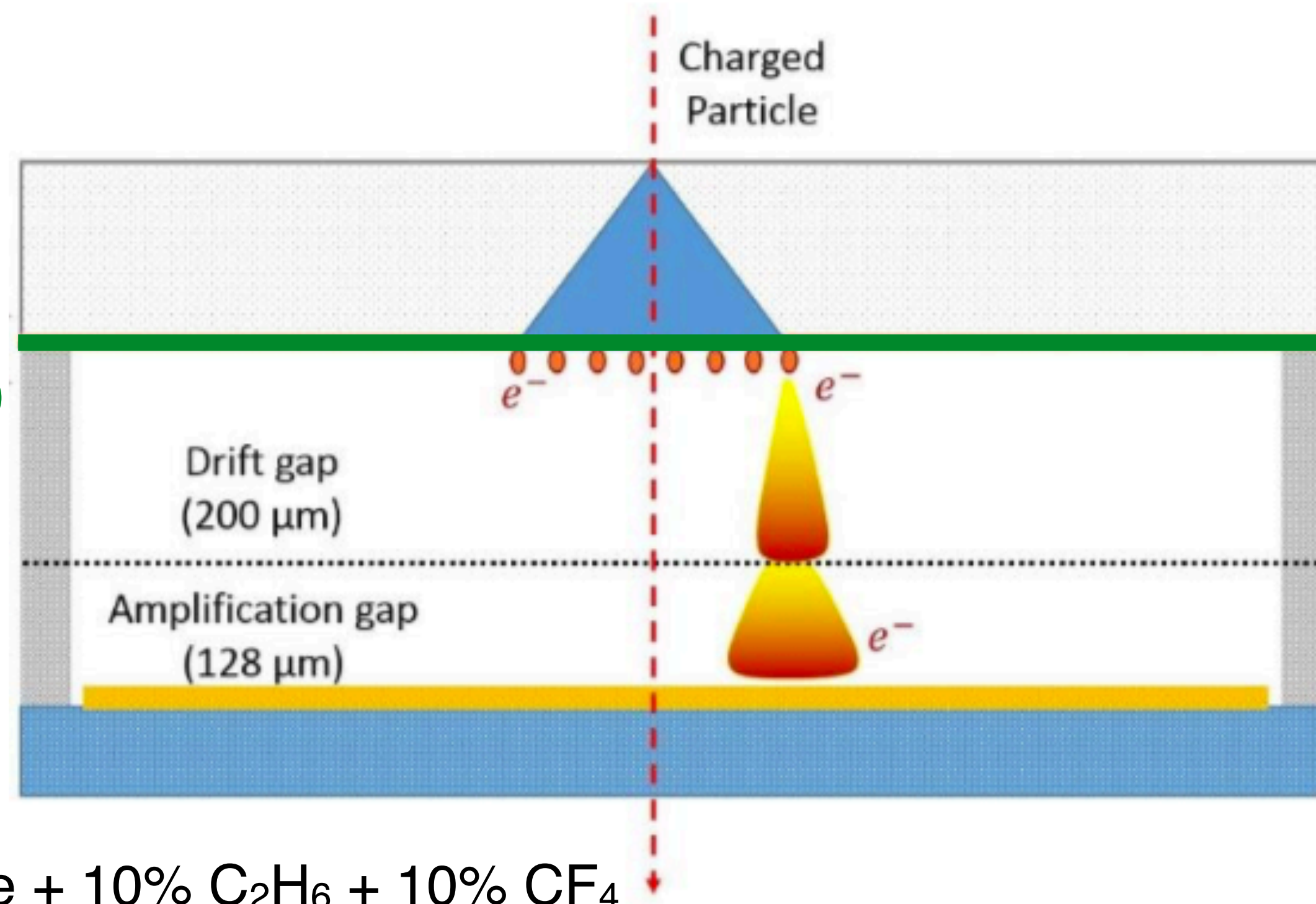

Gas mixture: 80% Ne + 10% C₂H₆ + 10% CF₄
(COMPASS gas)

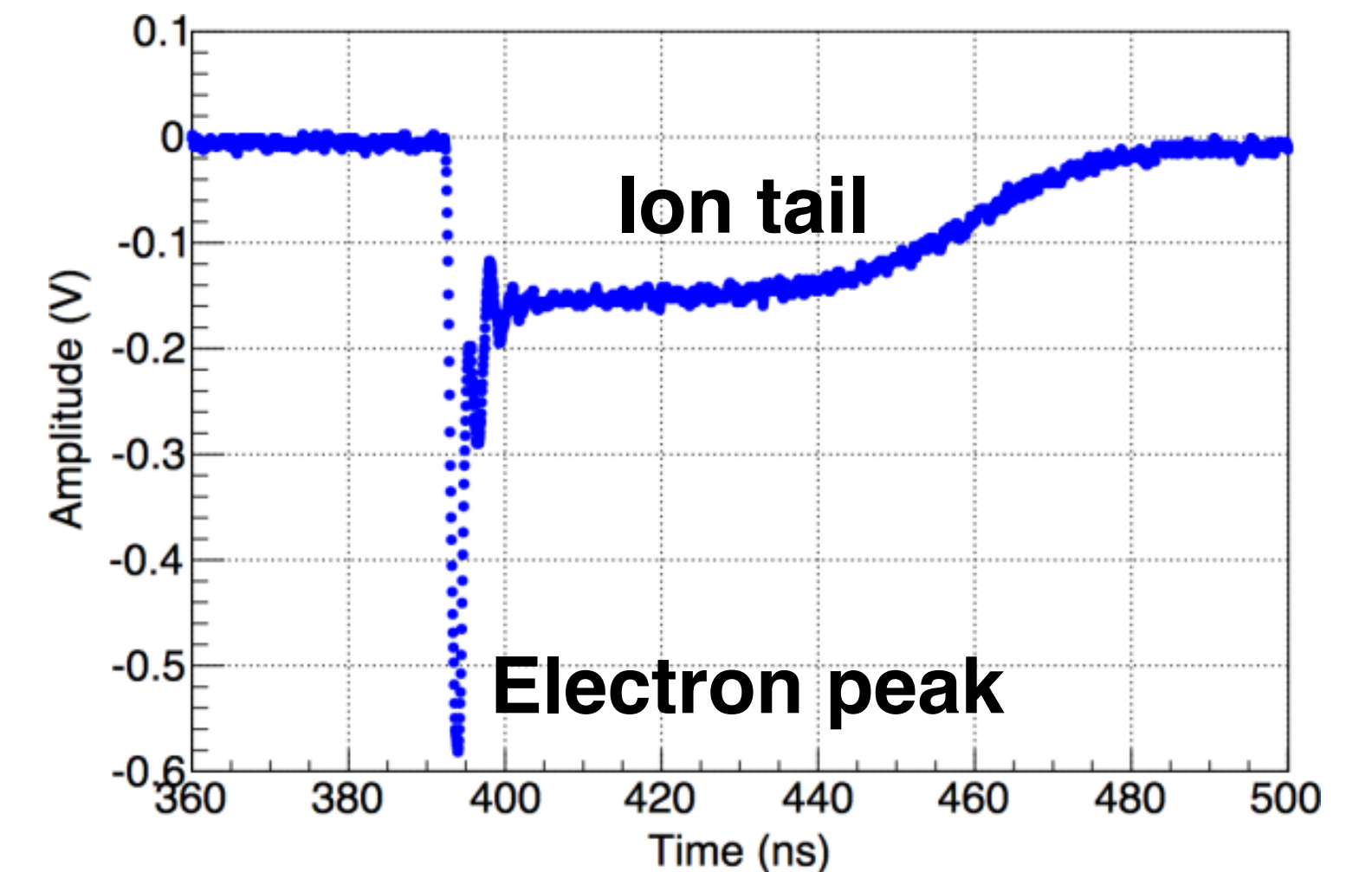

- **Signal with two distinct components:**
Electron peak: fast (≈ 0.5 ns)
- Ion tail: slow (≈ 100 ns)

PICOSEC detection concept

Precise timing with Micromegas

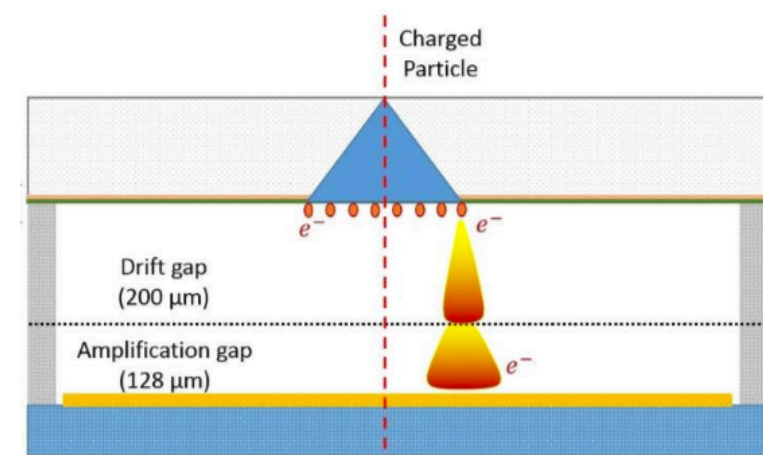

Preamplification of induced signal with CIVIDEC preamp

Digitized by 2.5GHz LeCroy oscilloscope
@ 20GSamples/s = 1 sample / 50 ps

Recorded waveform

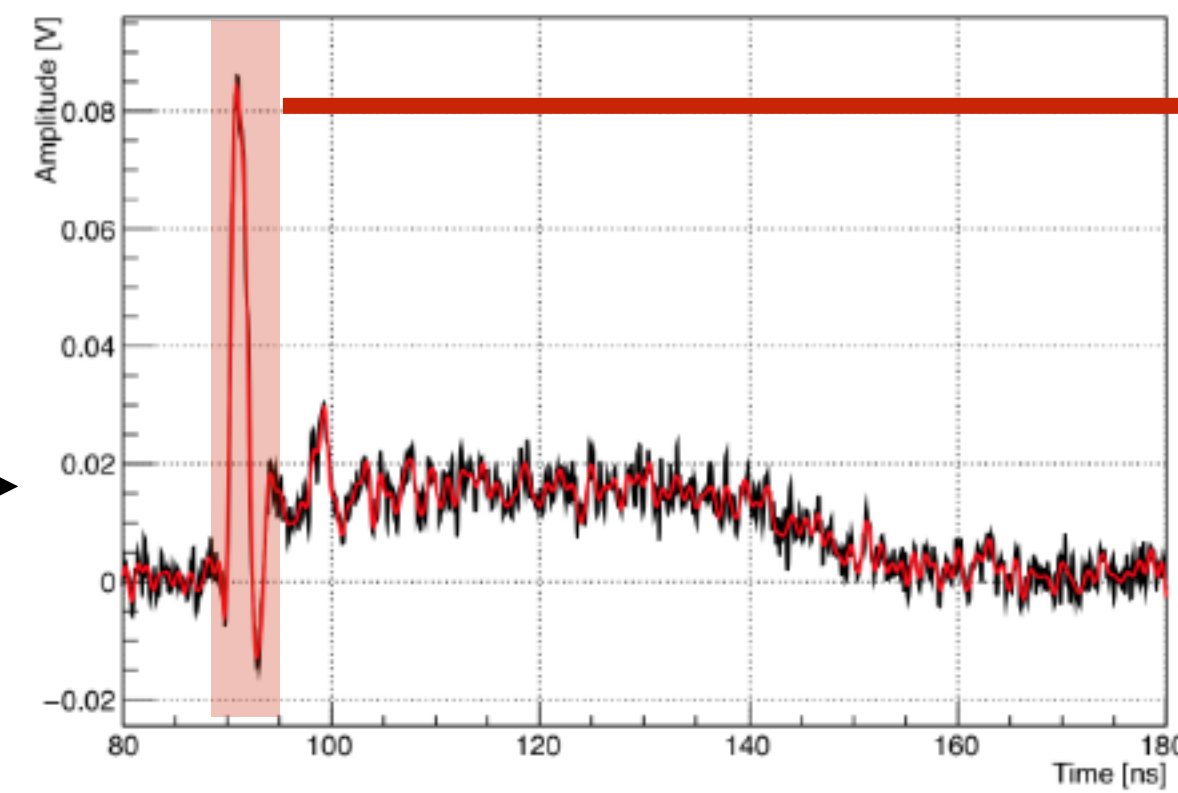

Zoom: electron peak

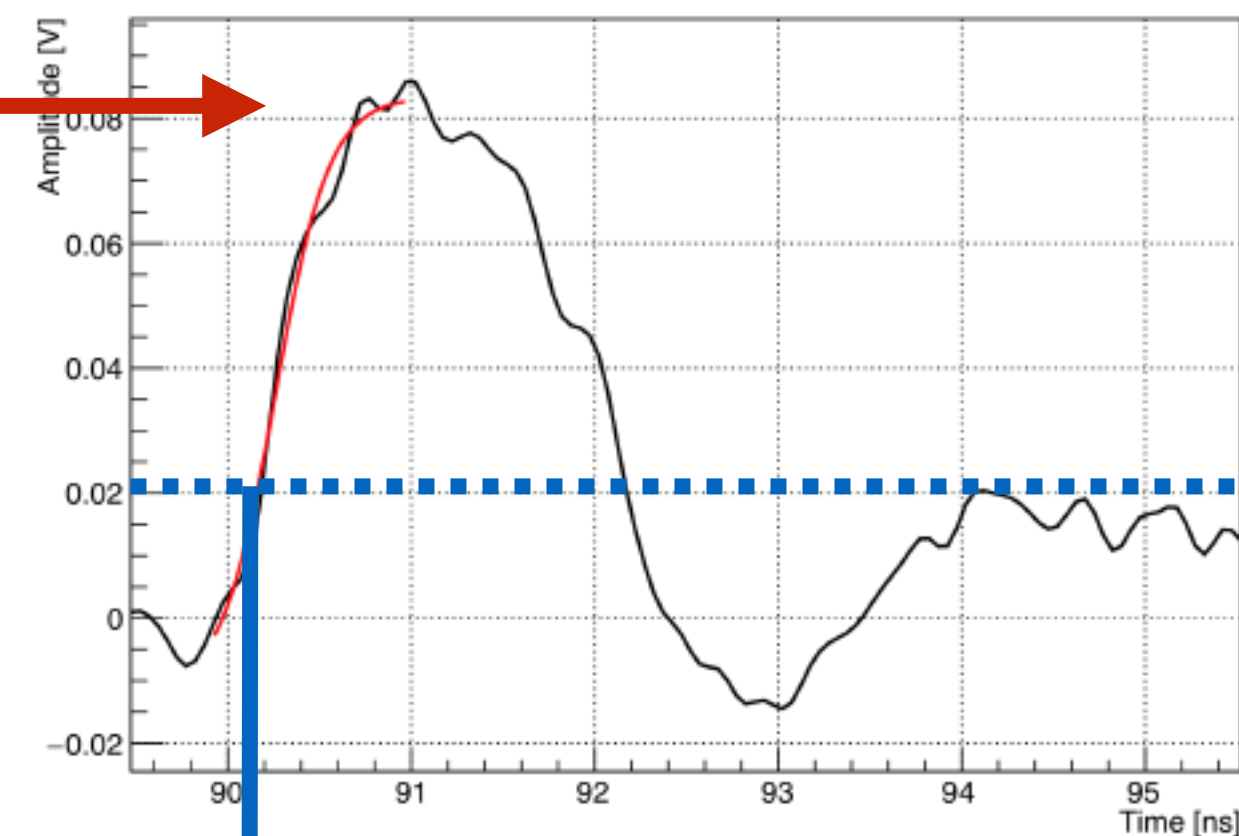

Constant Fraction Discrimination (**CFD**) at 20%
on the fitted noise-subtracted e-peak

Single photoelectron studies

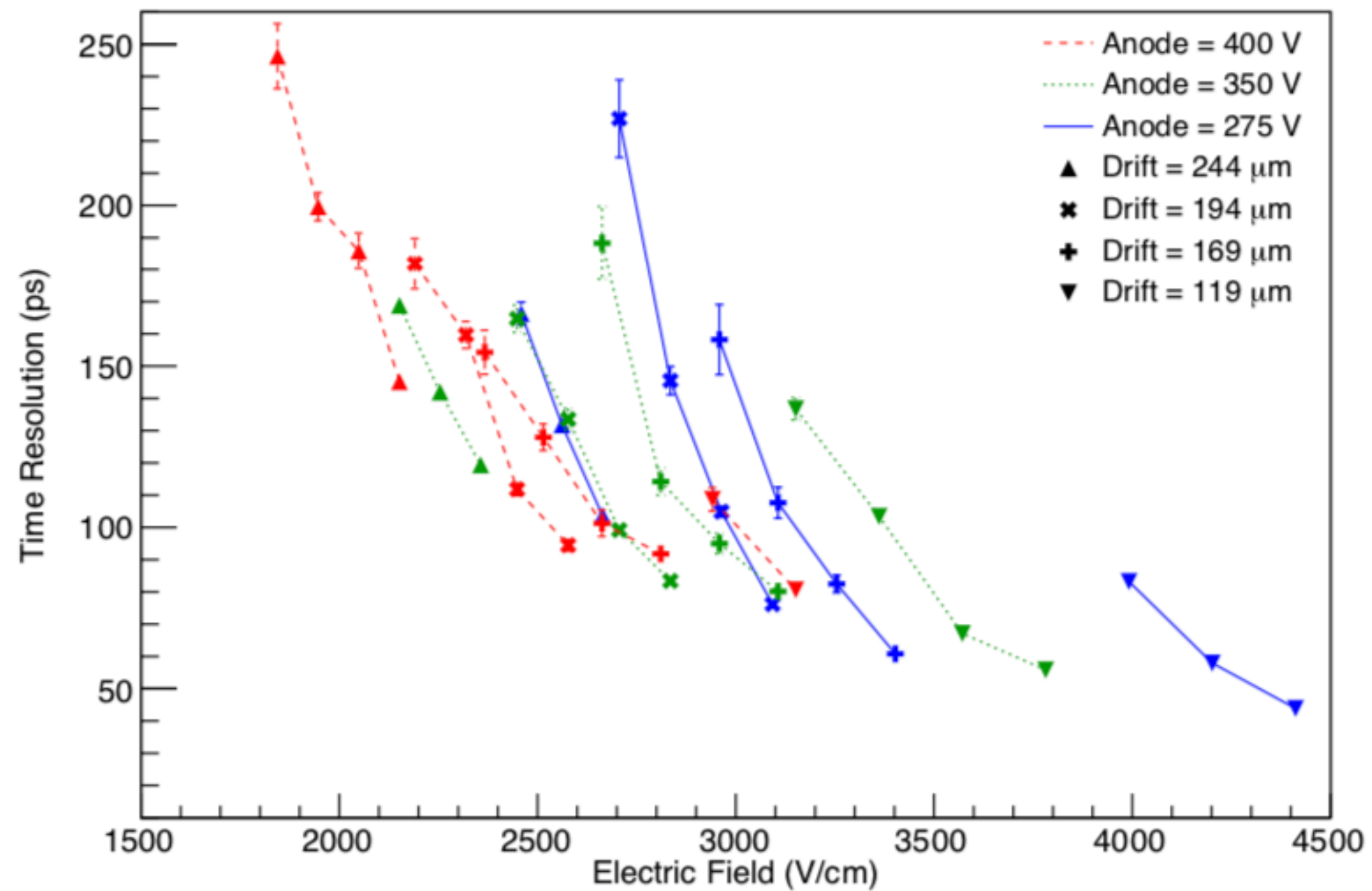

<50 ps single photoelectron timing resolution

MIP test beam measurements

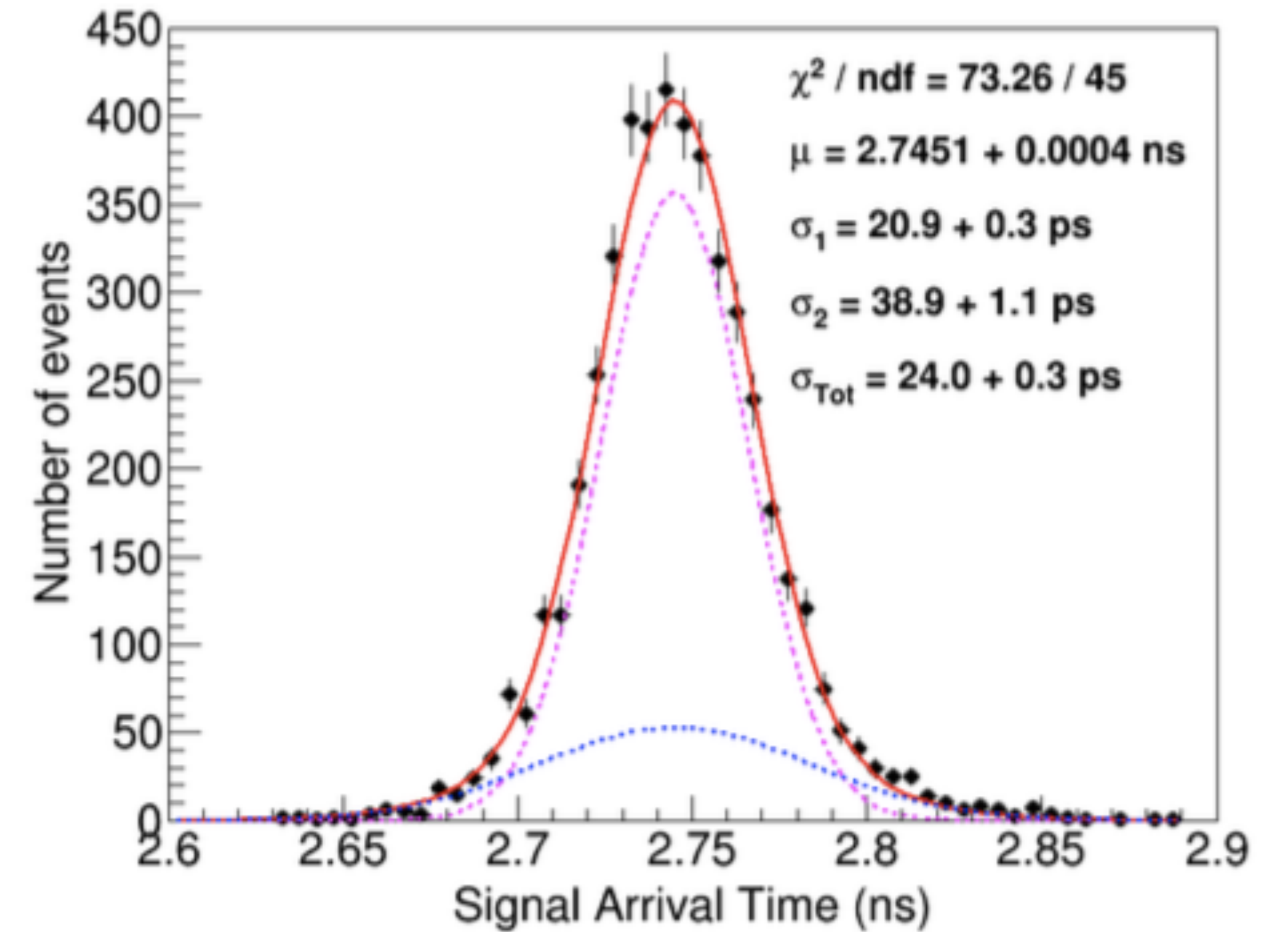

24 ps MIP timing resolution

Single photoelectron studies

Pulsed laser at IRAMIS facility (CEA Saclay)

Detailed detector response studies in well-controlled conditions: direct production of primary electrons at photocathode.

Fast photodiode (<5 ps resolution) as timing reference.

Allows for systemic studies and optimisations of

- Drift field strength
- Amplification field
- Gas mixtures

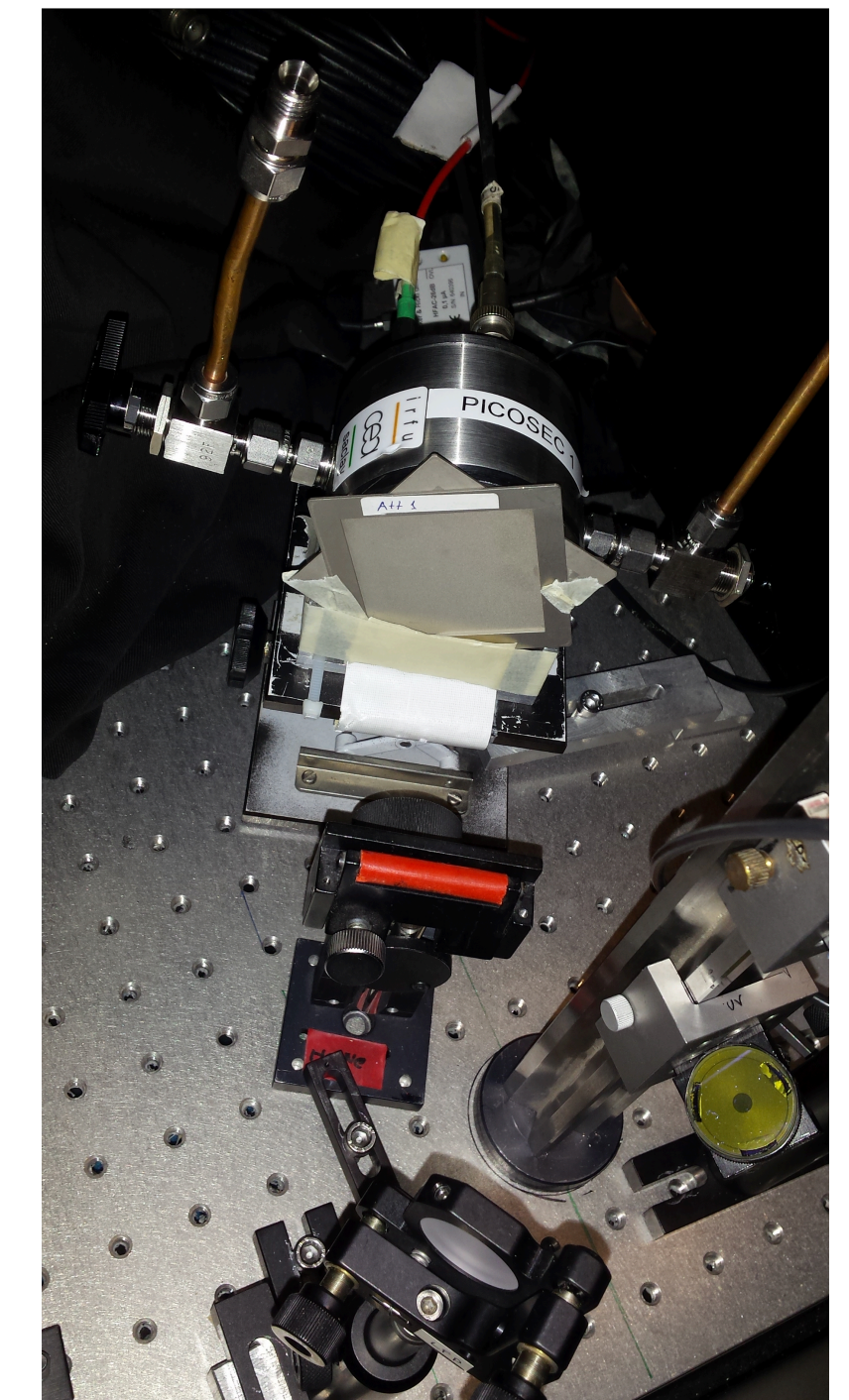
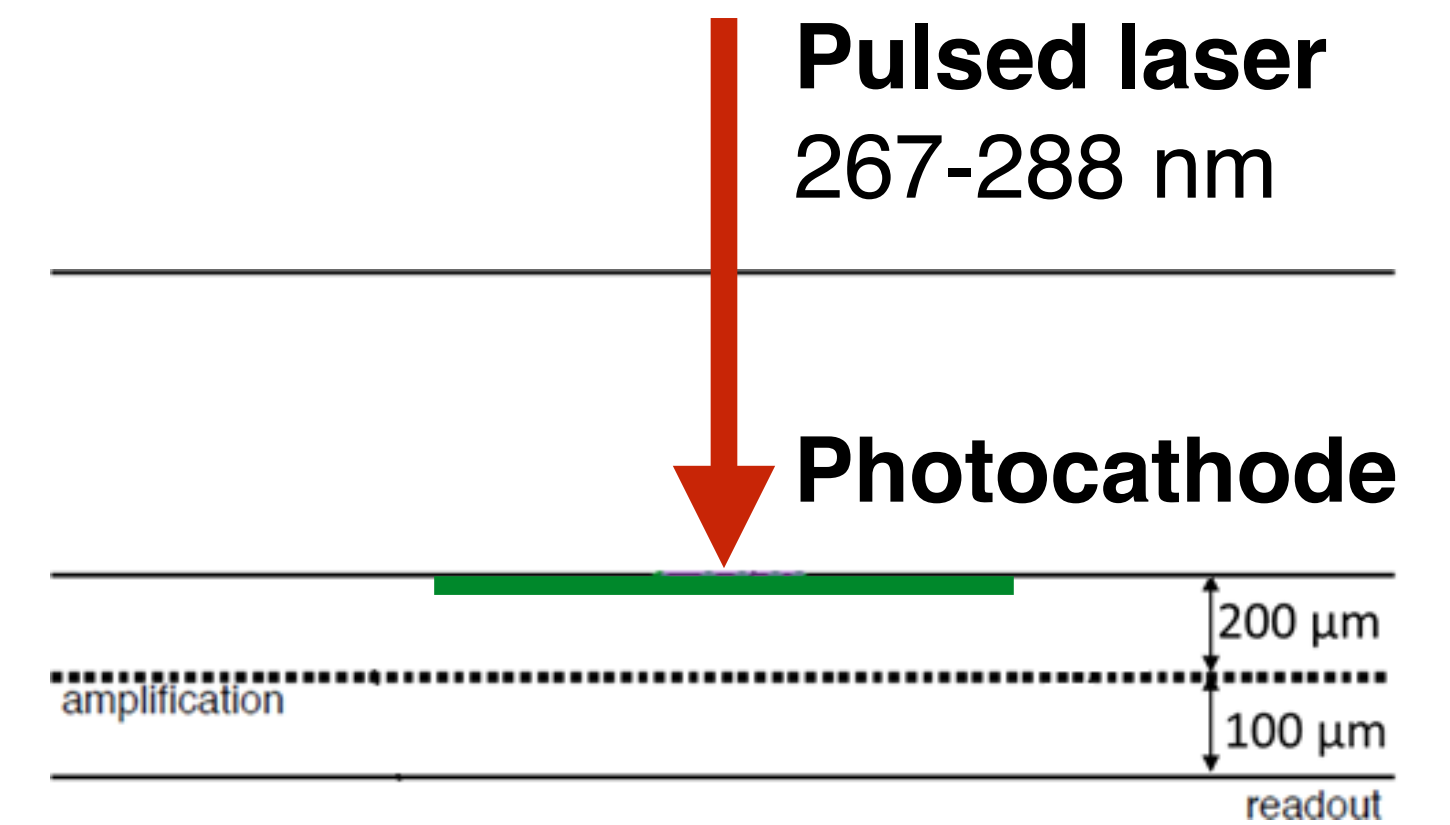

Detector response

Signal arrival time (SAT) = $\langle T_{e\text{-peak}} \rangle$

Time resolution = RMS ($T_{e\text{-peak}}$)

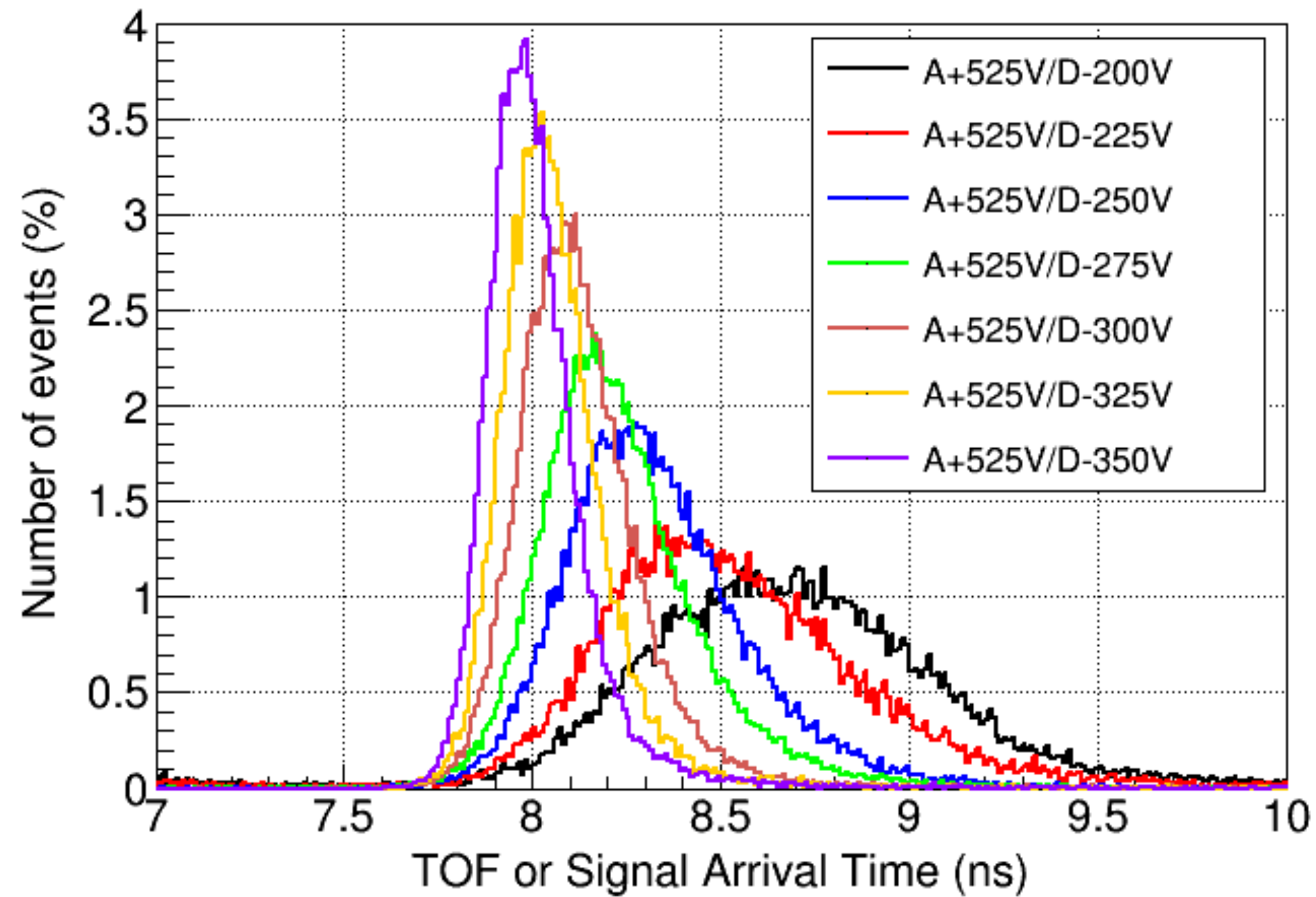
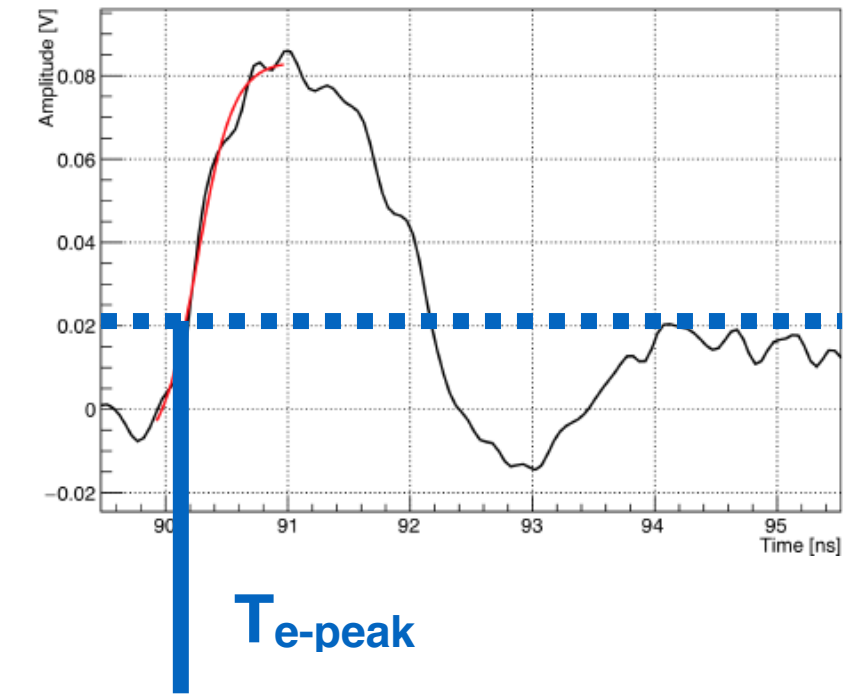

SAT distribution exhibits tail at higher values

Detector response

Correlation of signal arrival time and pulse amplitude

Time resolution depends primarily on e-peak charge

Signal arrival time

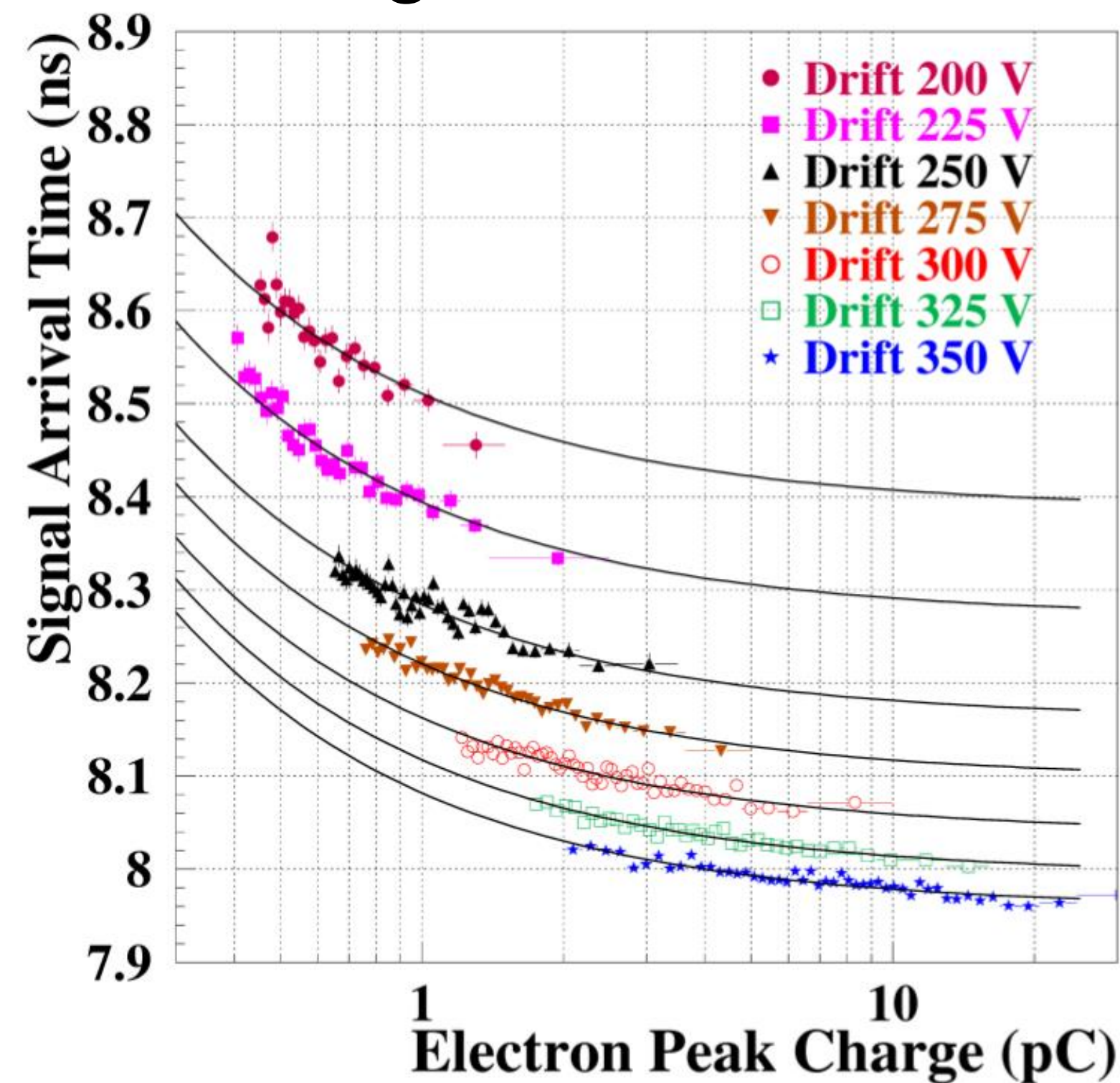

Time resolution

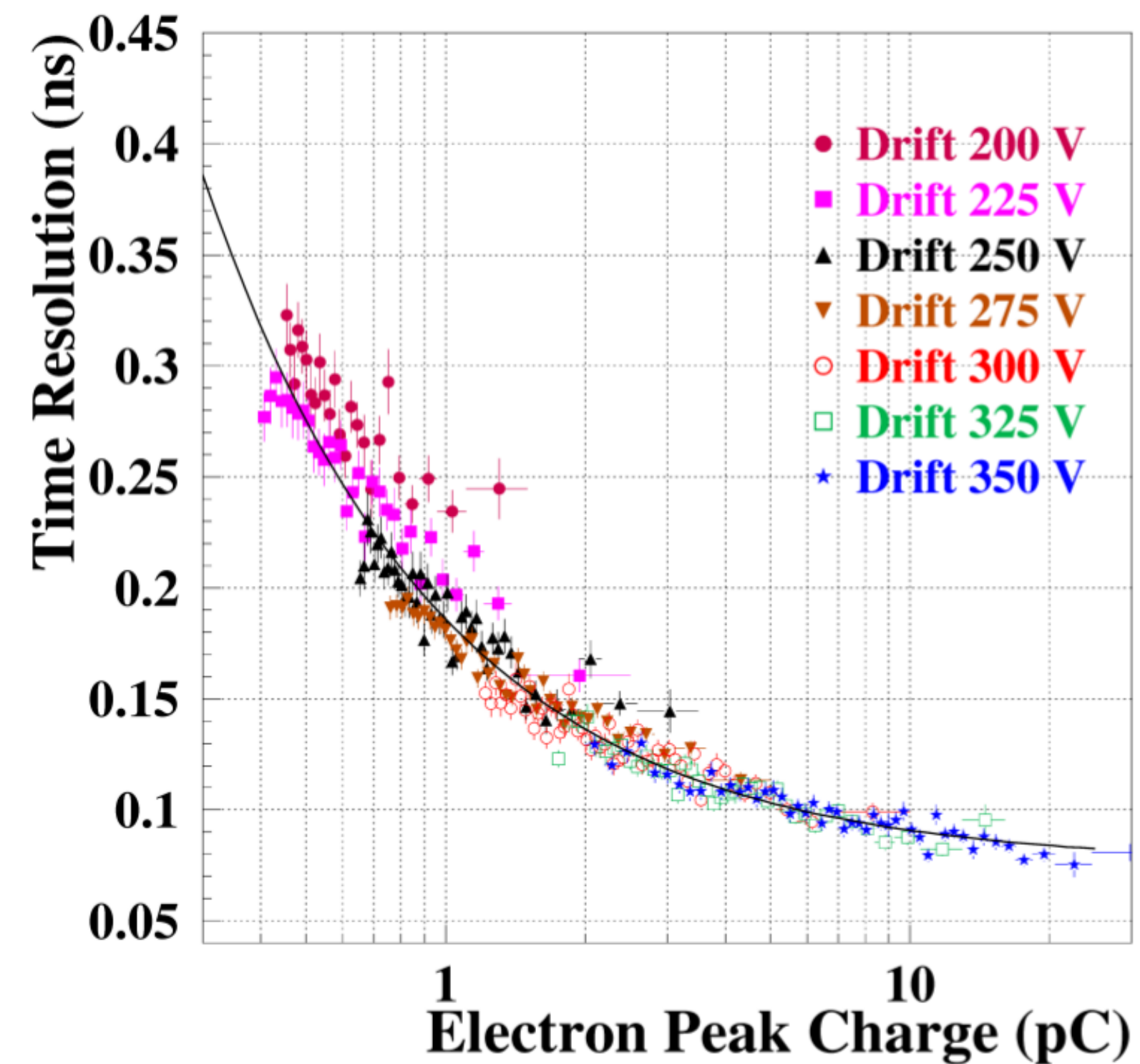

Detector response

Time resolution depends primarily on e-peak charge

SAT depends on e-peak size:

- bigger pulses -> lower SAT
- higher drift field -> lower SAT

Location of first ionisation determines length of avalanche

Longer avalanches result in bigger e-peak charge

SAT reduces with e-peak charge

K. Kordas, Progress on the PICOSEC-Micromegas Detector Development: towards a precise timing, radiation hard, large-scale particle detector with segmented readout, VCI2019 - The 15th Vienna Conference on Instrumentation
<https://indico.cern.ch/event/716539/contributions/3246636/>

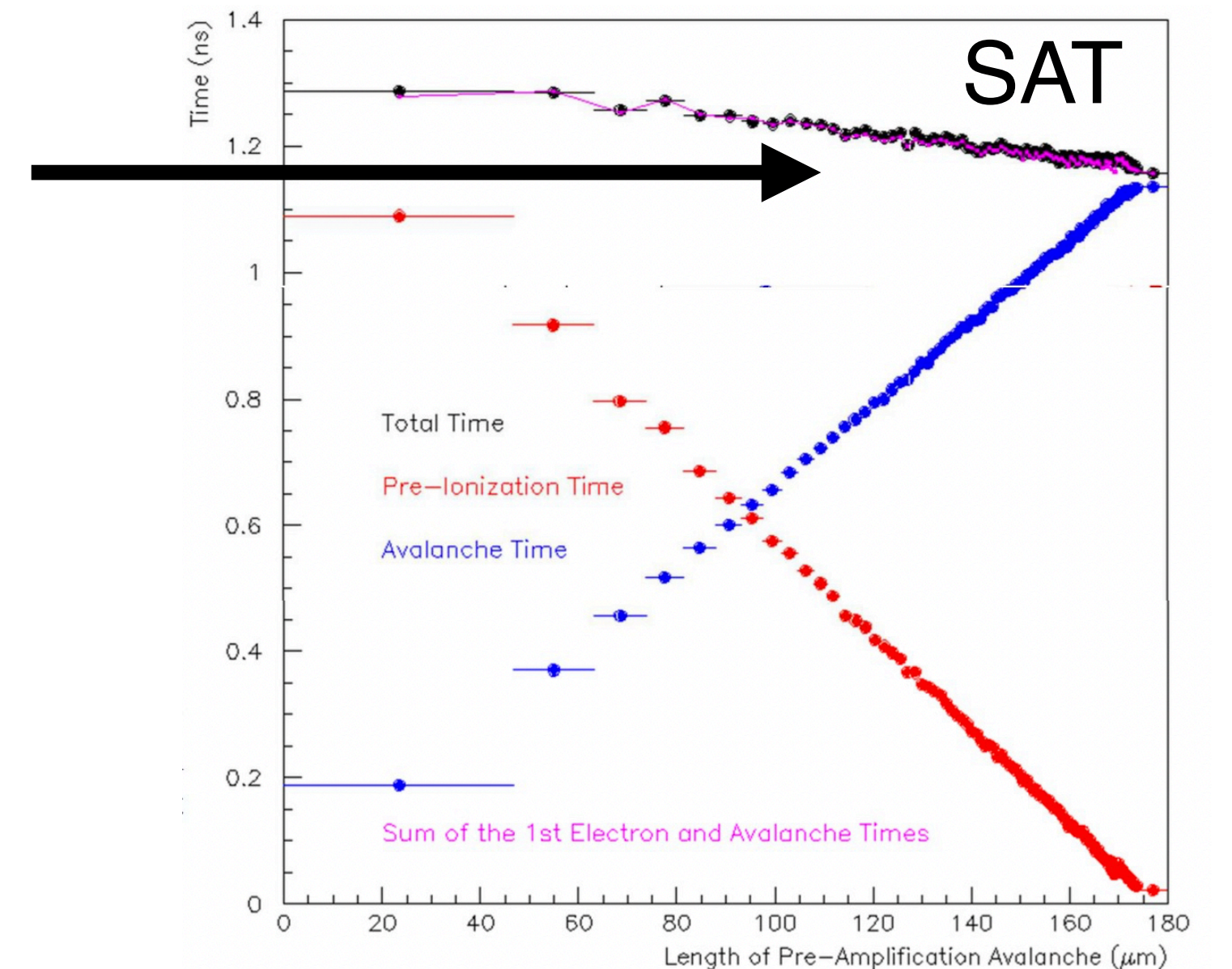
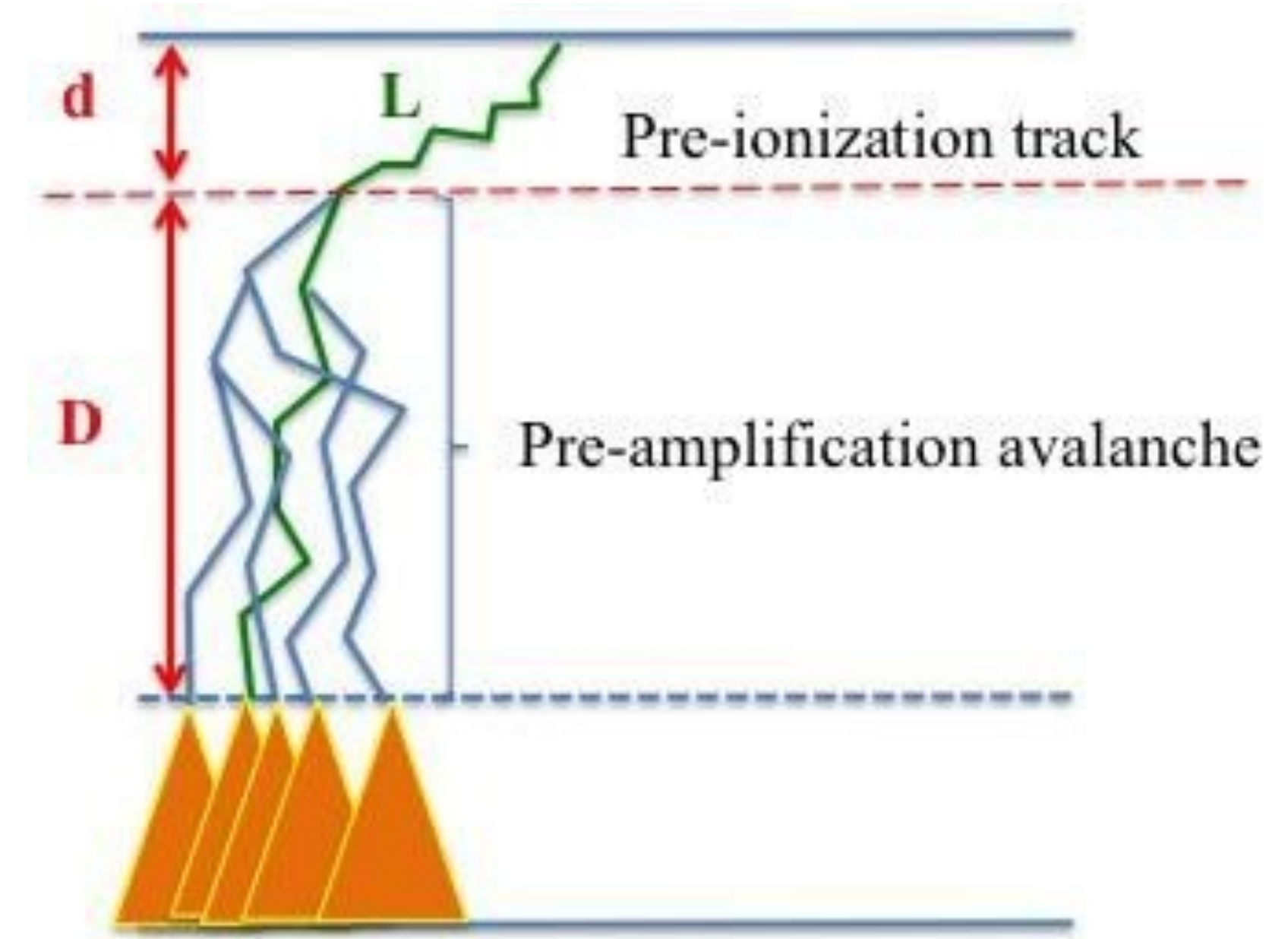

Avalanche length (μm)

Single photoelectron studies

Systematic tests of electric field configurations (drift / amplification fields), drift gaps and gas mixtures performed in laser facility

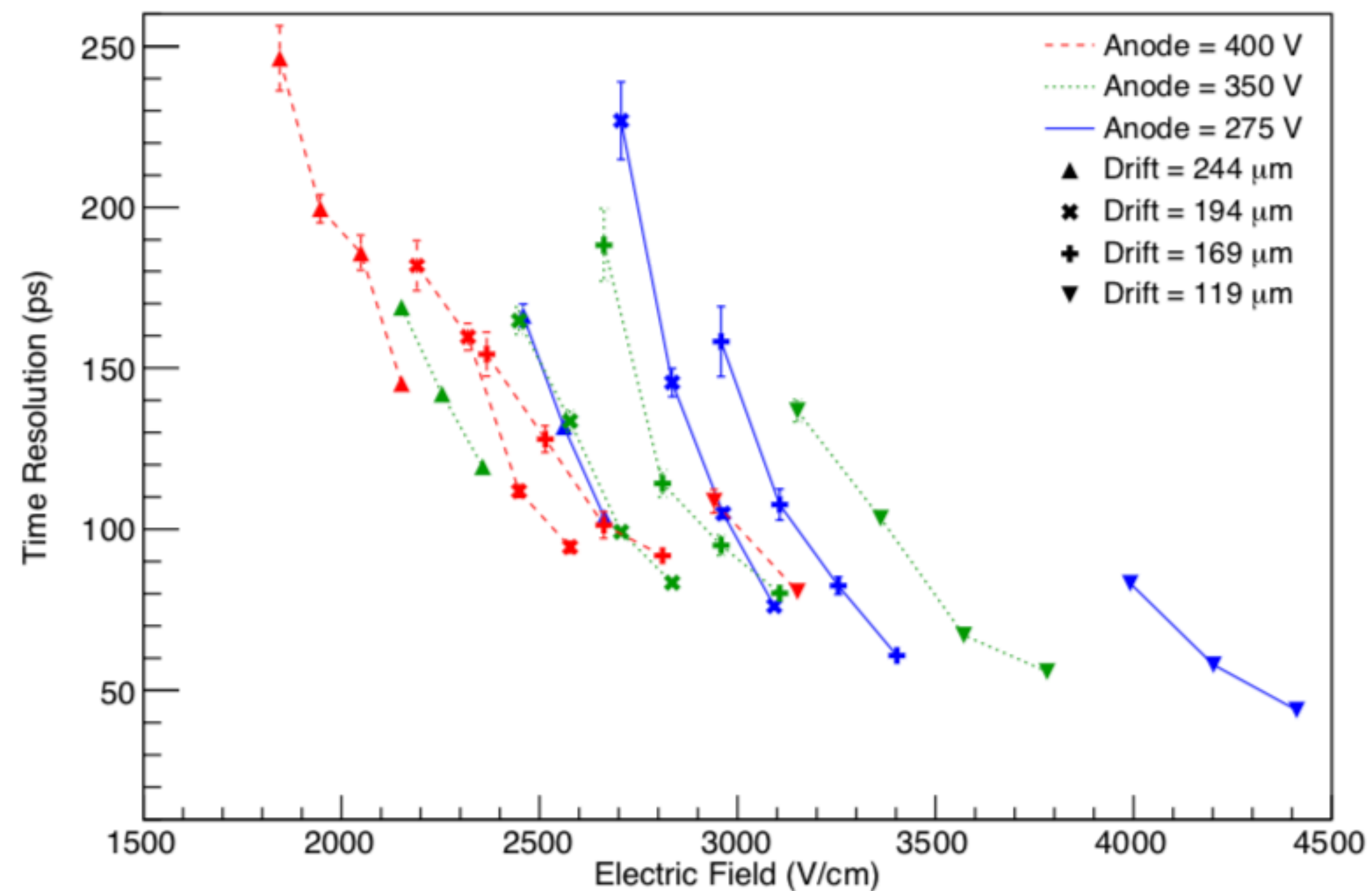

Time resolution improves with electric field

Smaller drift gap has better performance at same gain

Shorter drift time of the first electron before starting an avalanche gives a better time resolution

L. Sohl, et al., Single photoelectron time resolution studies of the PICOSEC-Micromegas detector, JINST Proc. of the 15th Topical Seminar on Innovative Particle and Radiation Detectors 2019, InPress (2020)

MIP beam tests

Completed several beam test campaigns at CERN SPS H4 beam line
150 GeV muons and pions

Two **MCP-PMTs** used as timing reference (<5 ps resolution)

Scintillator as DAQ trigger to select tracking regions

Tracking system with triple-GEMs (40 μm precision)

CIVIDEC preamp + 2.5 GHz oscilloscopes

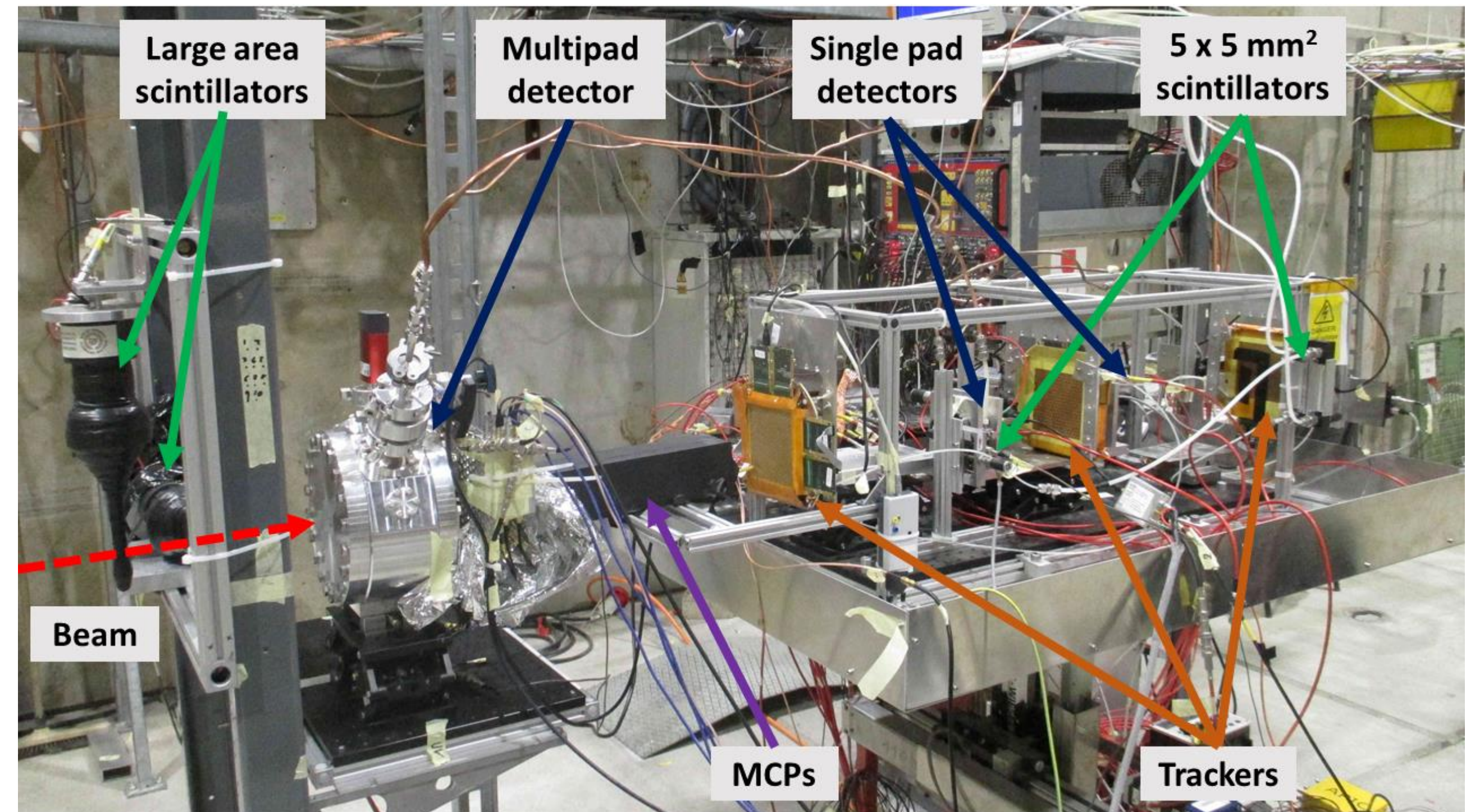
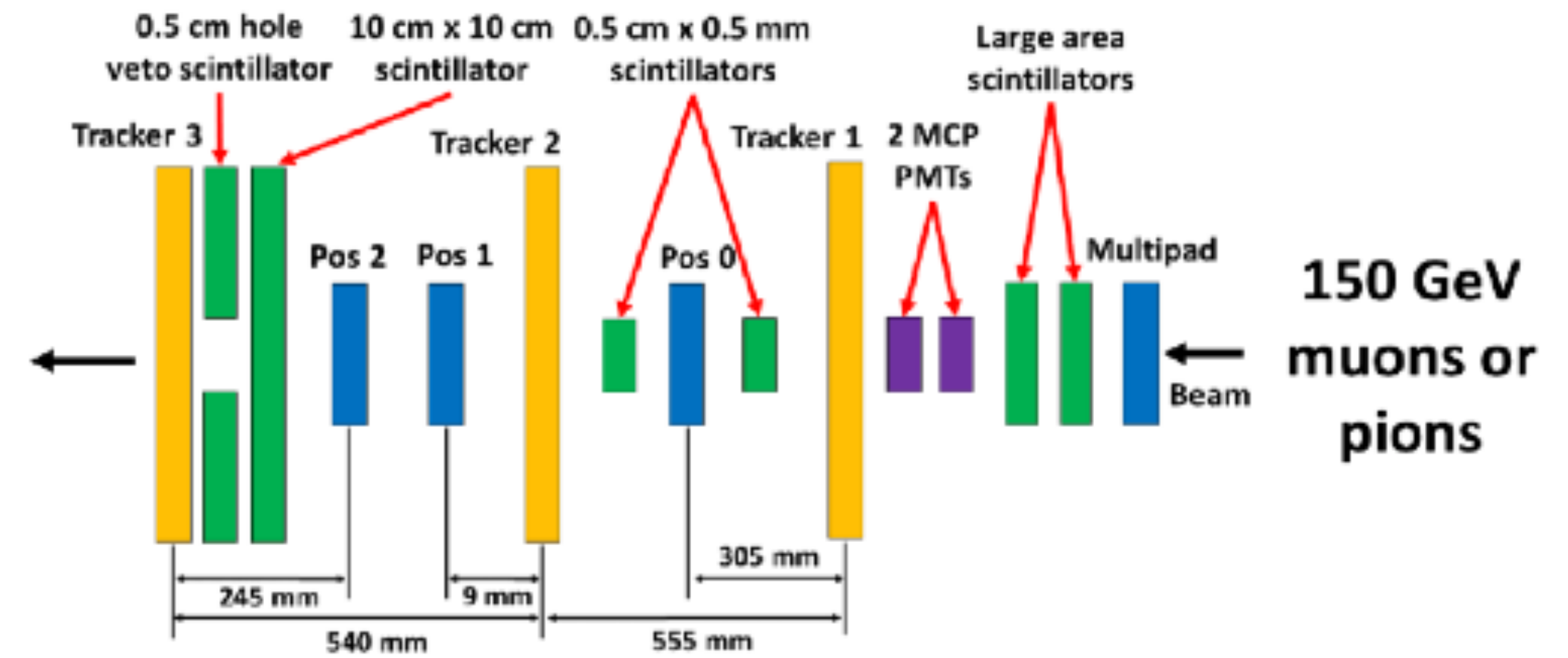

MIP beam tests

Time resolution for 150 GeV muons: 24 ps

Optimum operation point: Anode +275 V / Drift – 475 V

Mean number of photoelectrons per muon = 10.4 ± 0.4

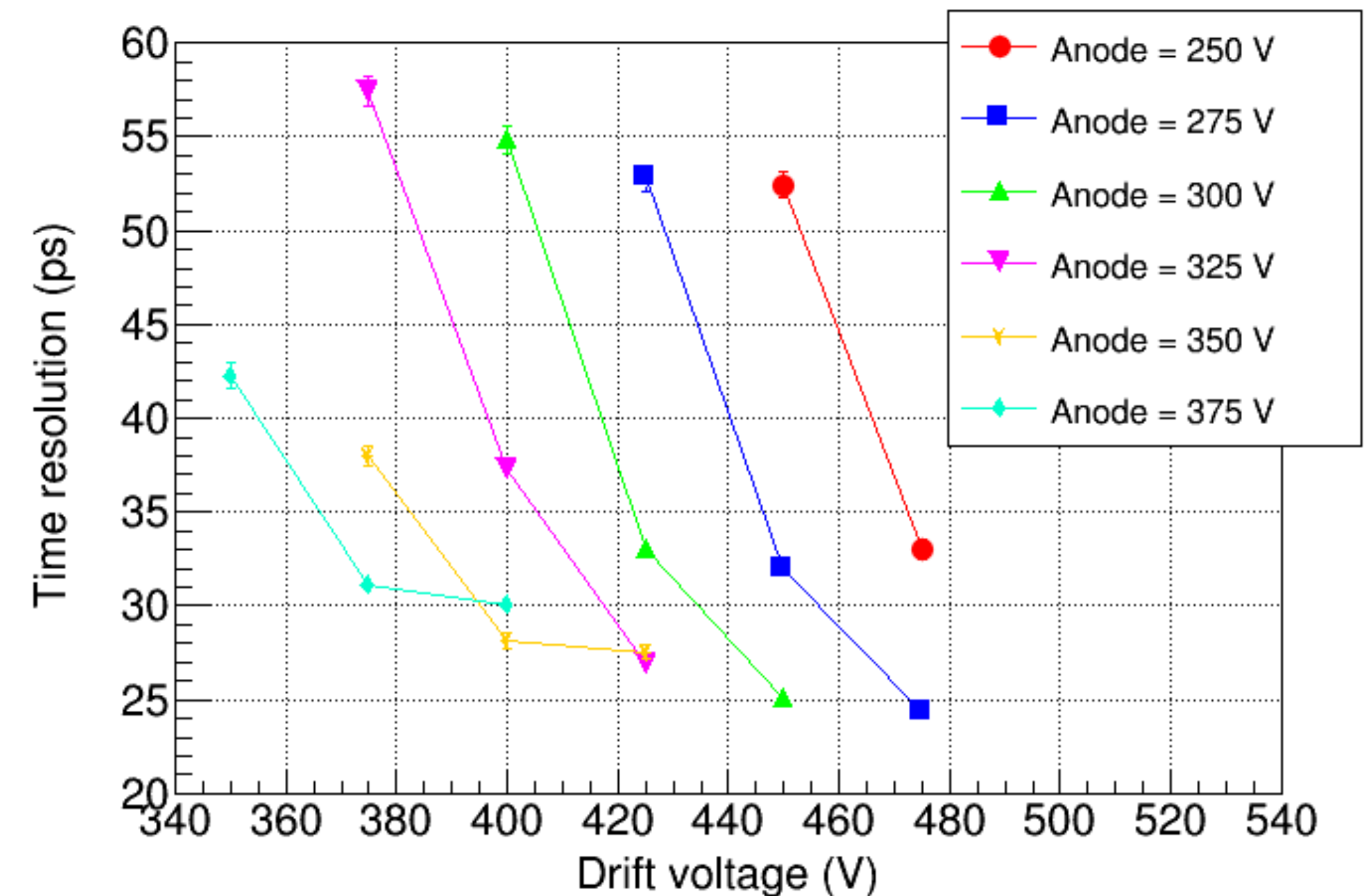
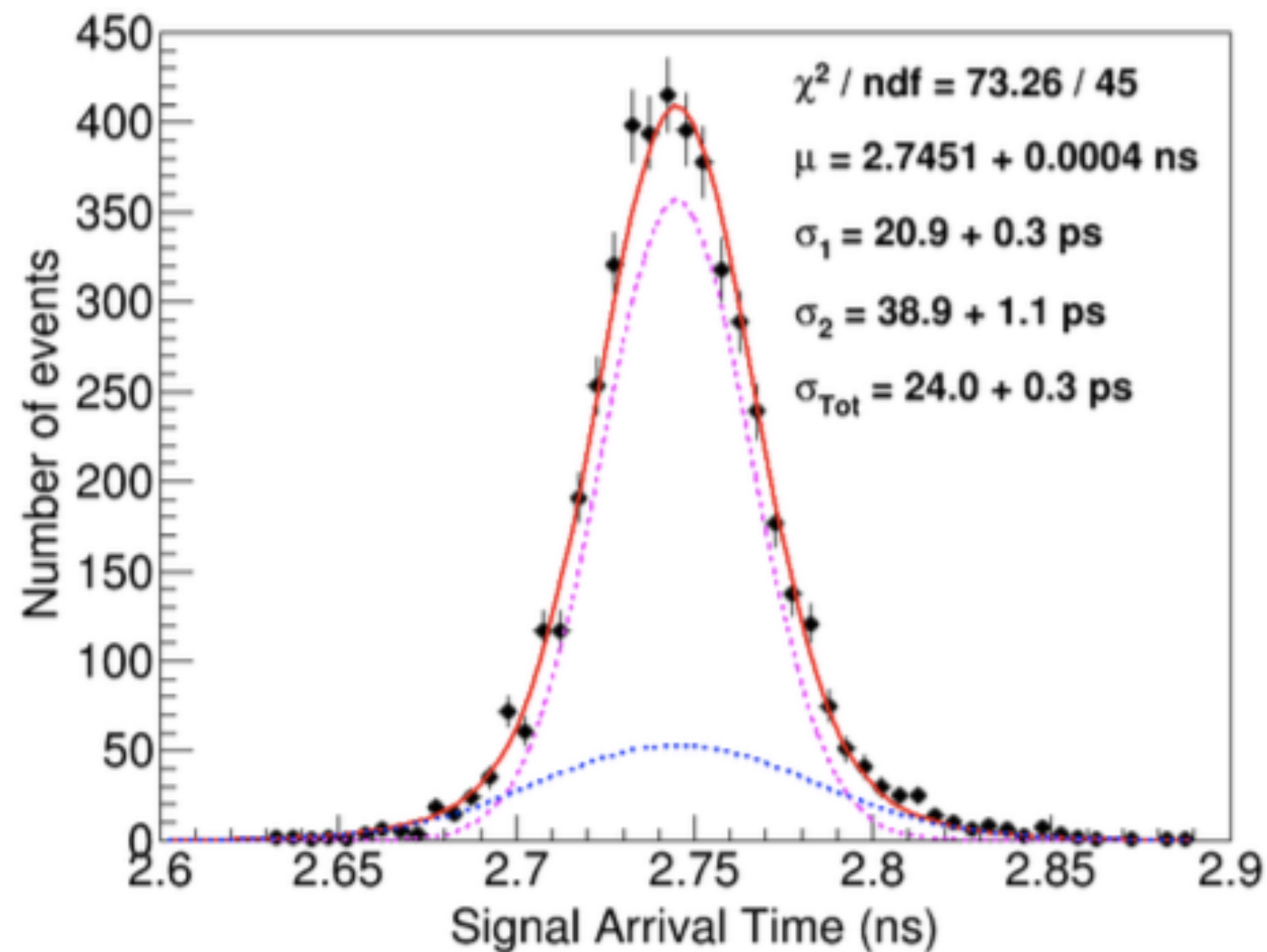
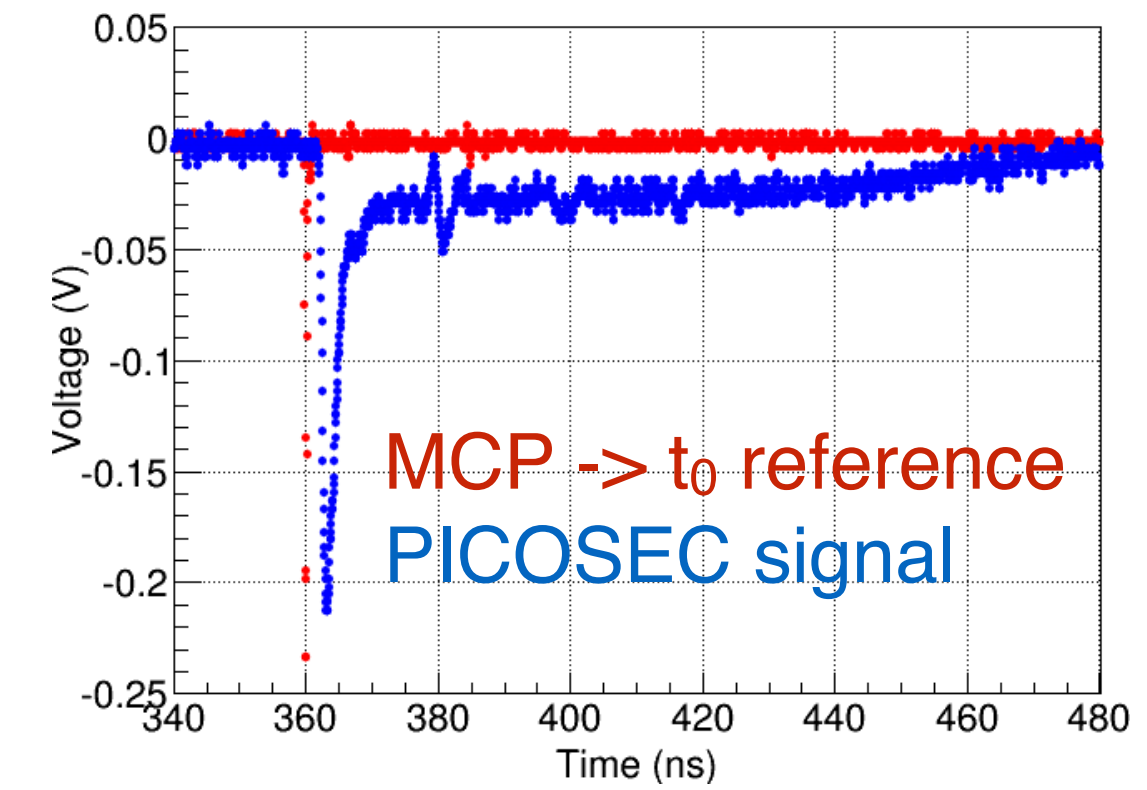

Next steps

Towards a robust, large-area detector

Towards a robust, large-area detector

Based on promising timing precision achieved in beam tests, the PICOSEC collaboration is working towards an applicable detector by addressing robustness of Micromegas and photocathodes as well as scaling up to cover larger areas.

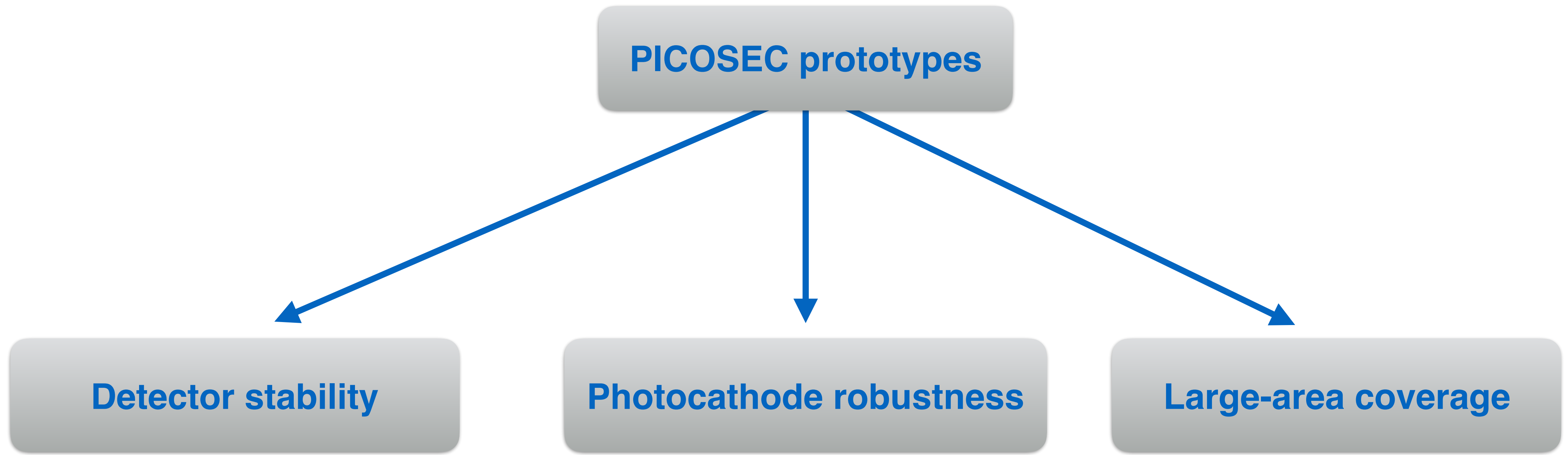

Towards a robust, large-area detector

Detector stability Resistive Micromegas

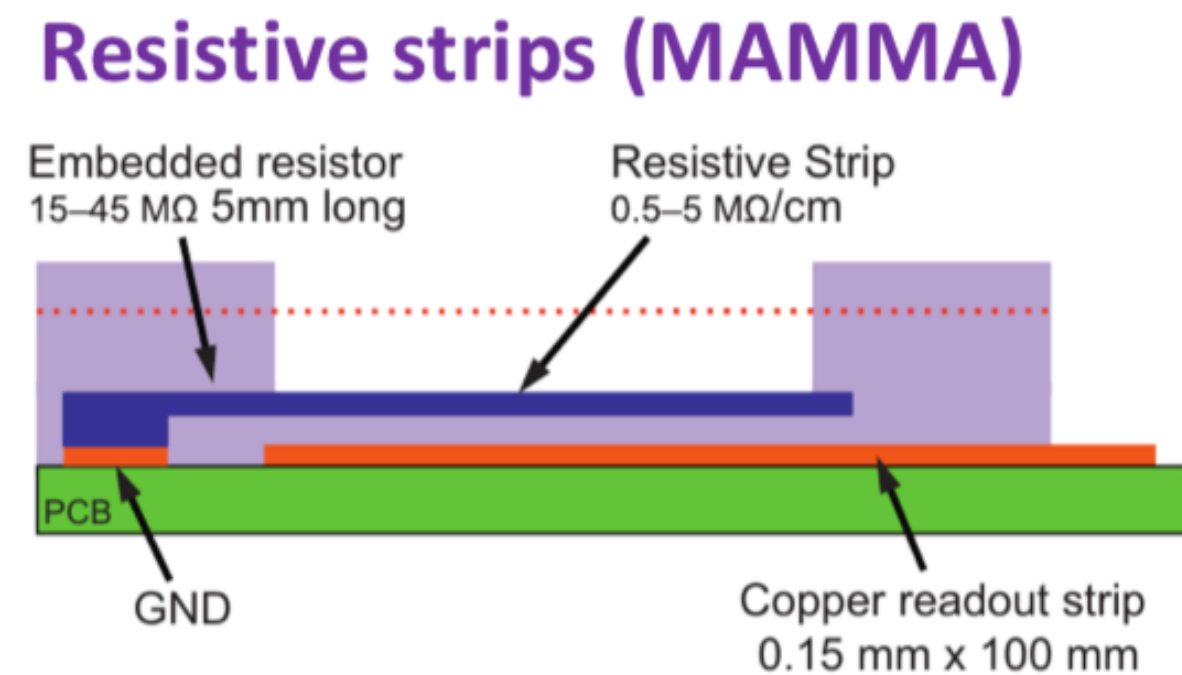

T. Alexopoulos *et al.*, *NIMA* **640** (2011) 110-118.

Photocathode robustness

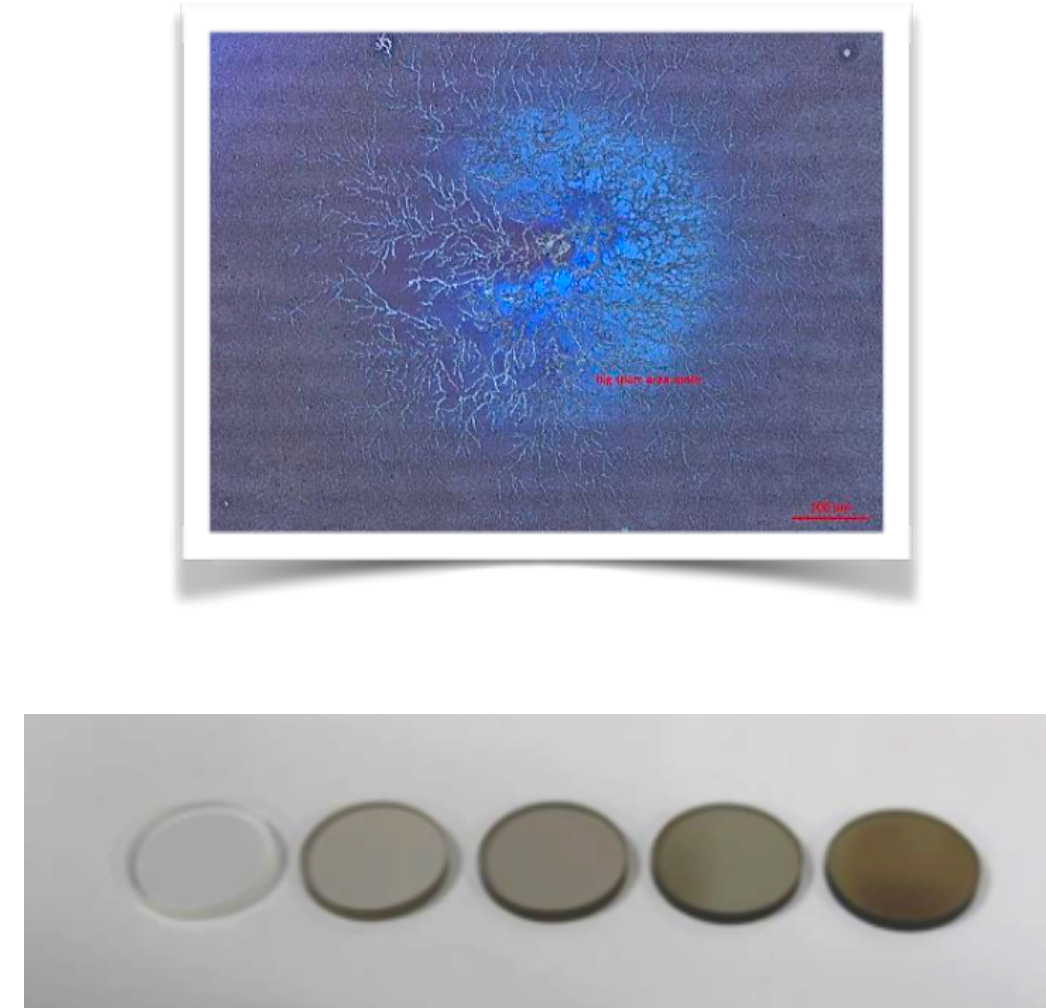

Large-area coverage From single pad to multi-pad module

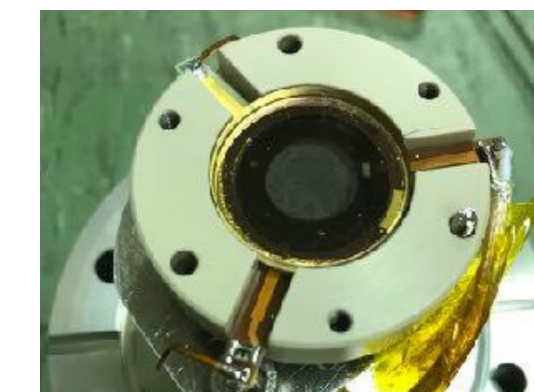

Single pad (2016)
ø1 cm

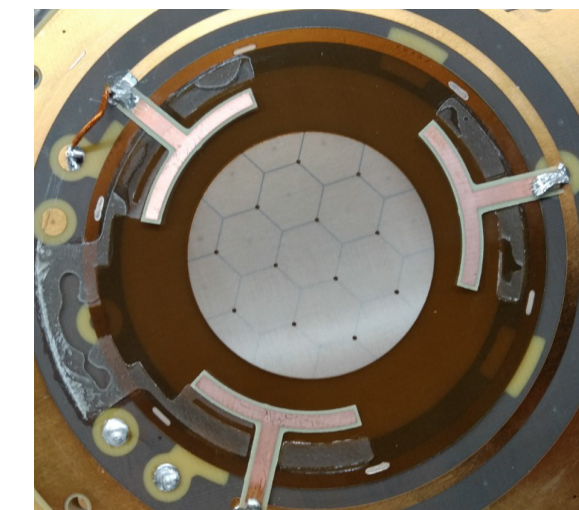

Multi pad (2017)
⬡ 1 cm

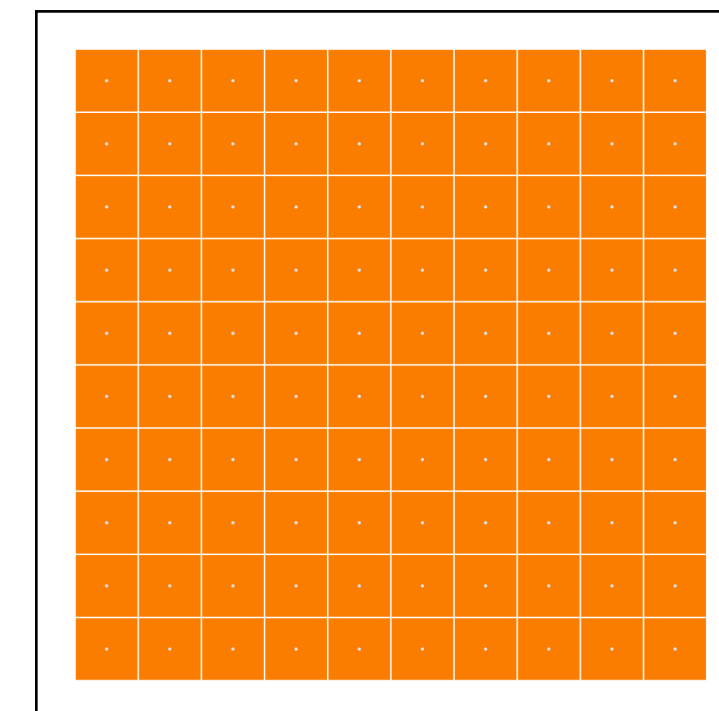

10x10 module
□ 1 cm

Detector stability

Resistive Micromegas

Limiting destructive effect of discharges but employing resistive elements for readout anodes

Two design approaches tested and evaluated in beam test campaigns

Resistive strips (MAMMA)

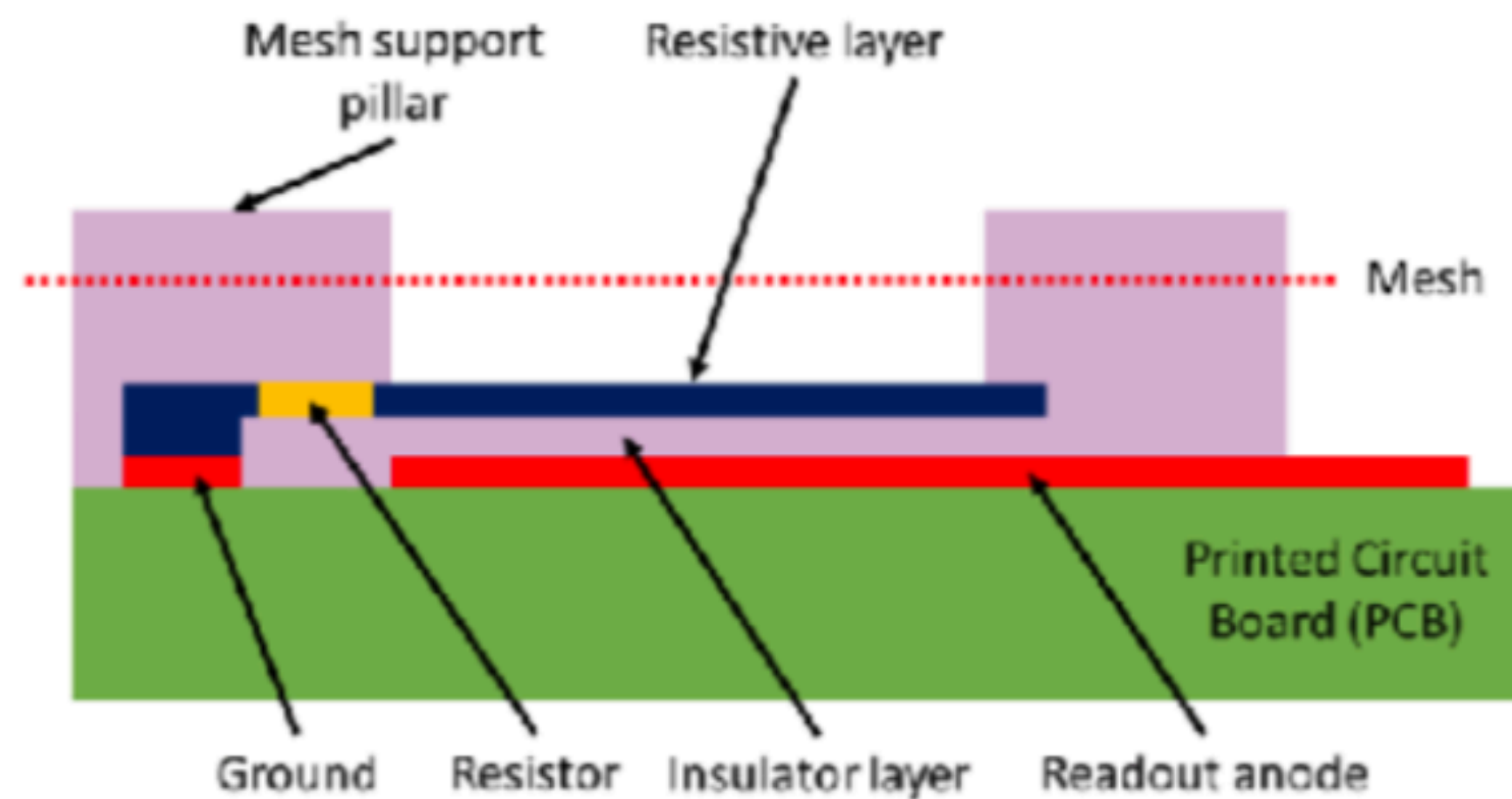

Floating strips (COMPASS)

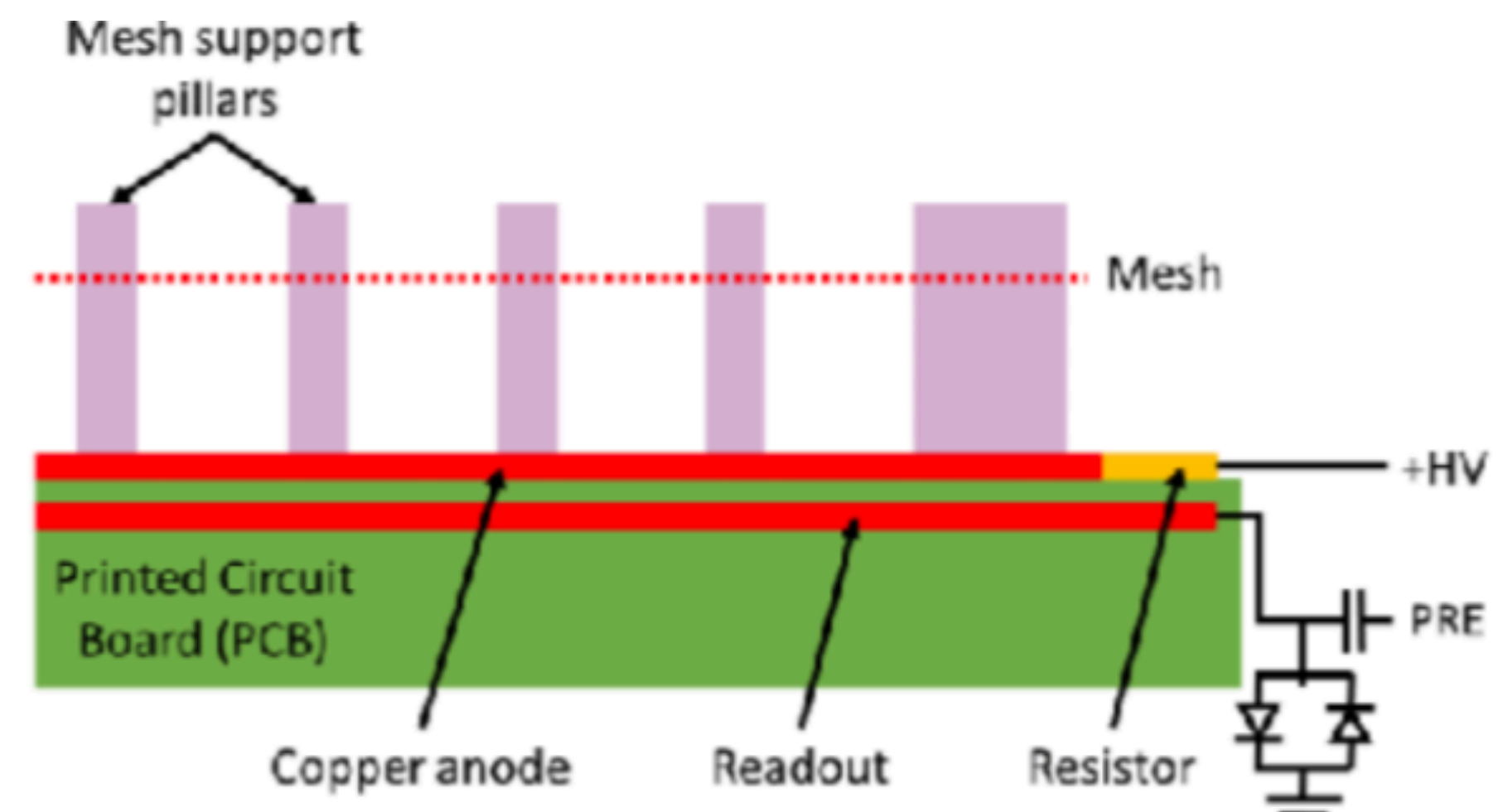

T. Alexopoulos et al., NIMA **640** (2011) 110-118

Detector stability

Resistive Micromegas

Achieved time resolution close to PICOSEC bulk readout.

Stable operation in intense pion beam

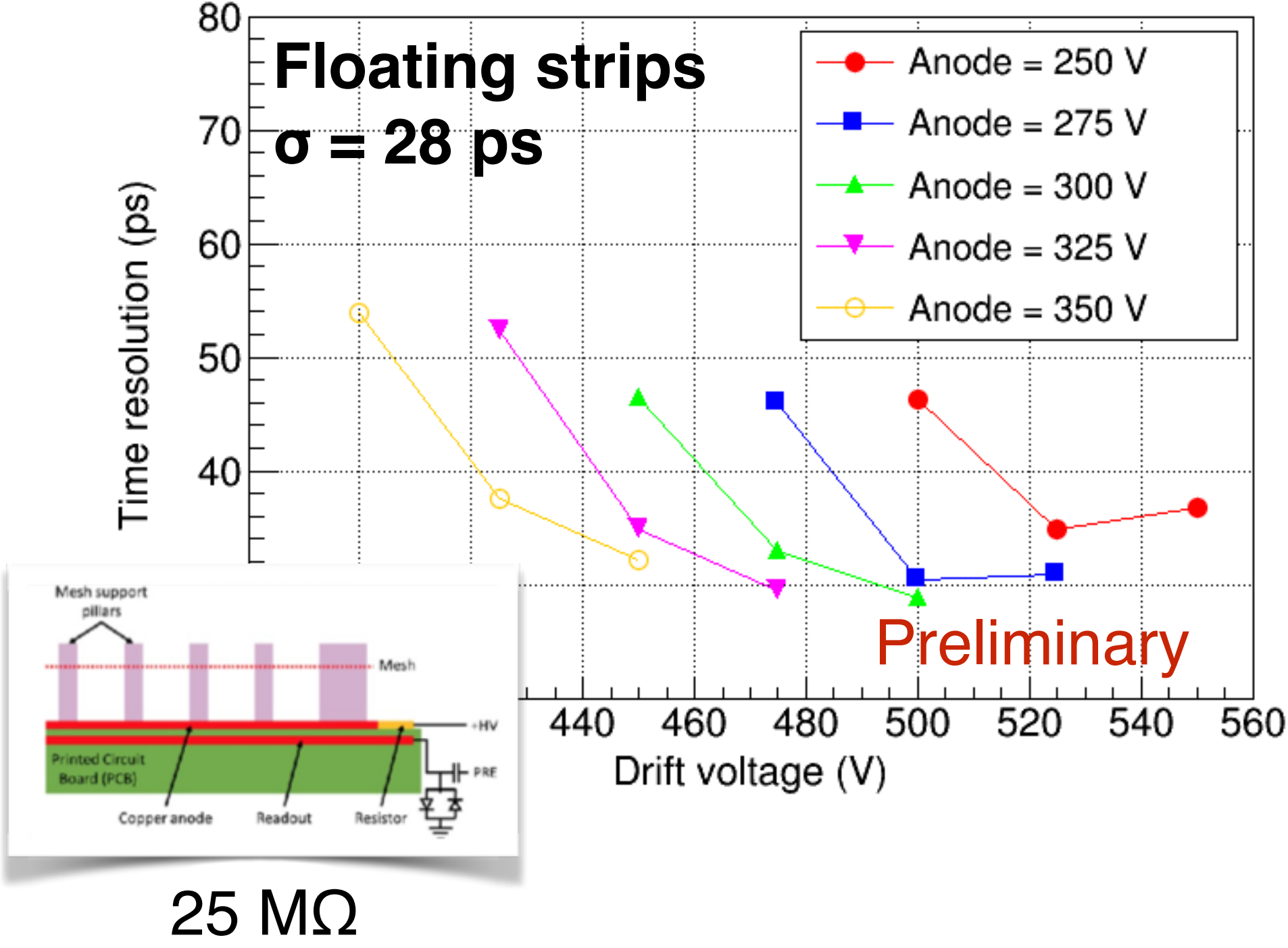
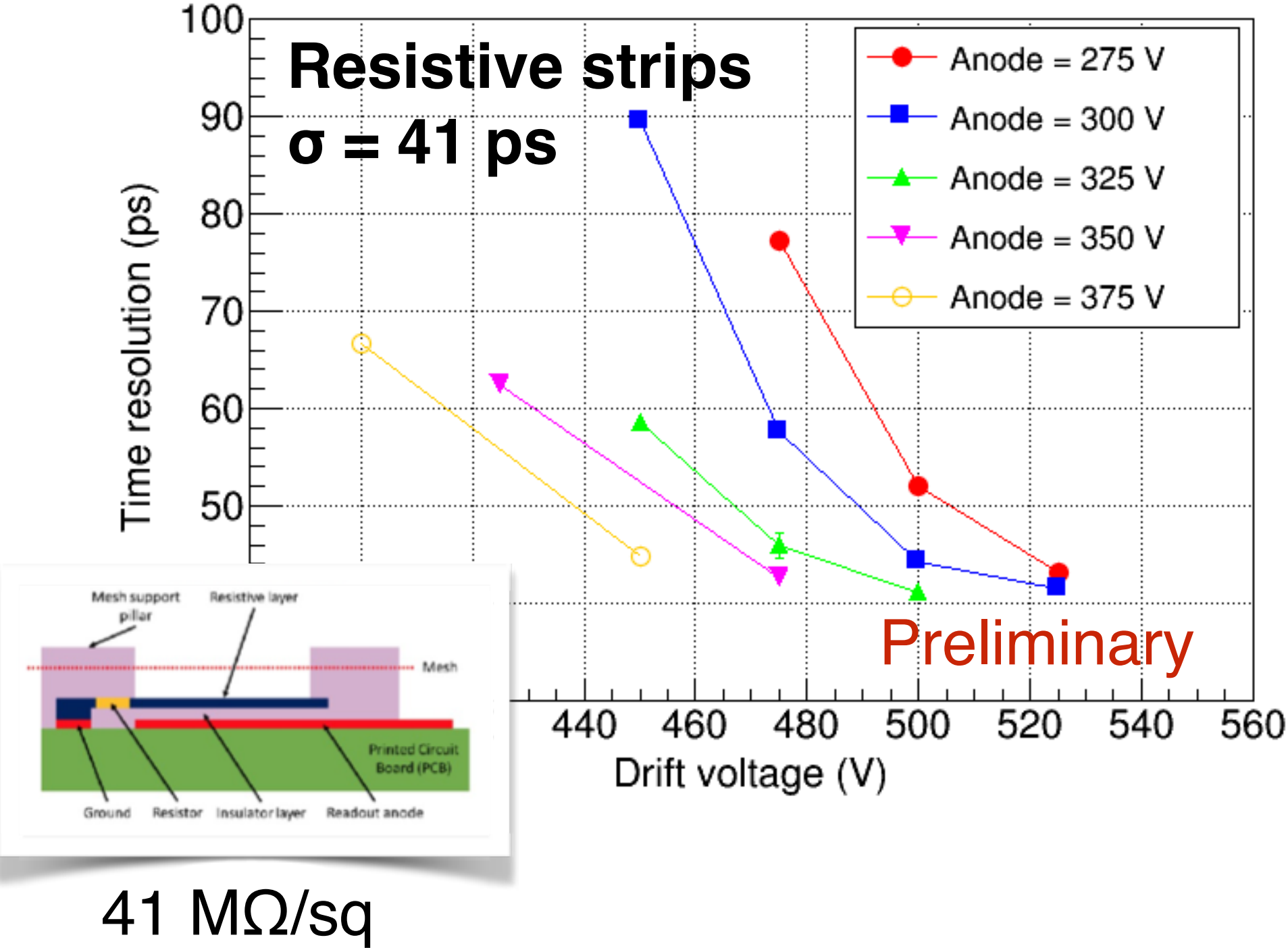

Photocathode robustness

Problems with CsI

Standard PICOSEC photocathode: 18 nm CsI + 3 nm Cr

CsI sensitive to humidity, ion backflow and sparks

CsI photocathode after spark

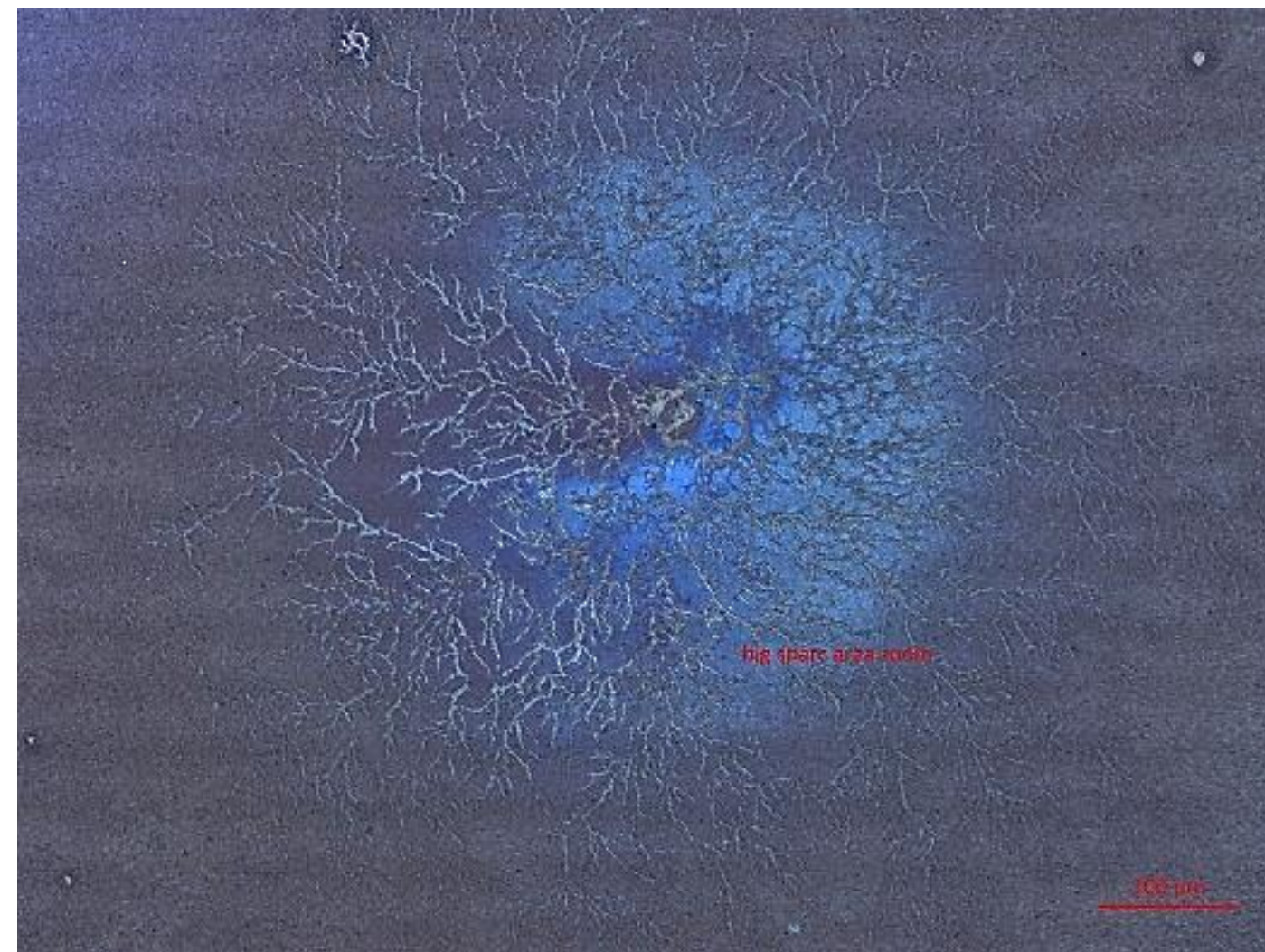

Ion backflow on CsI

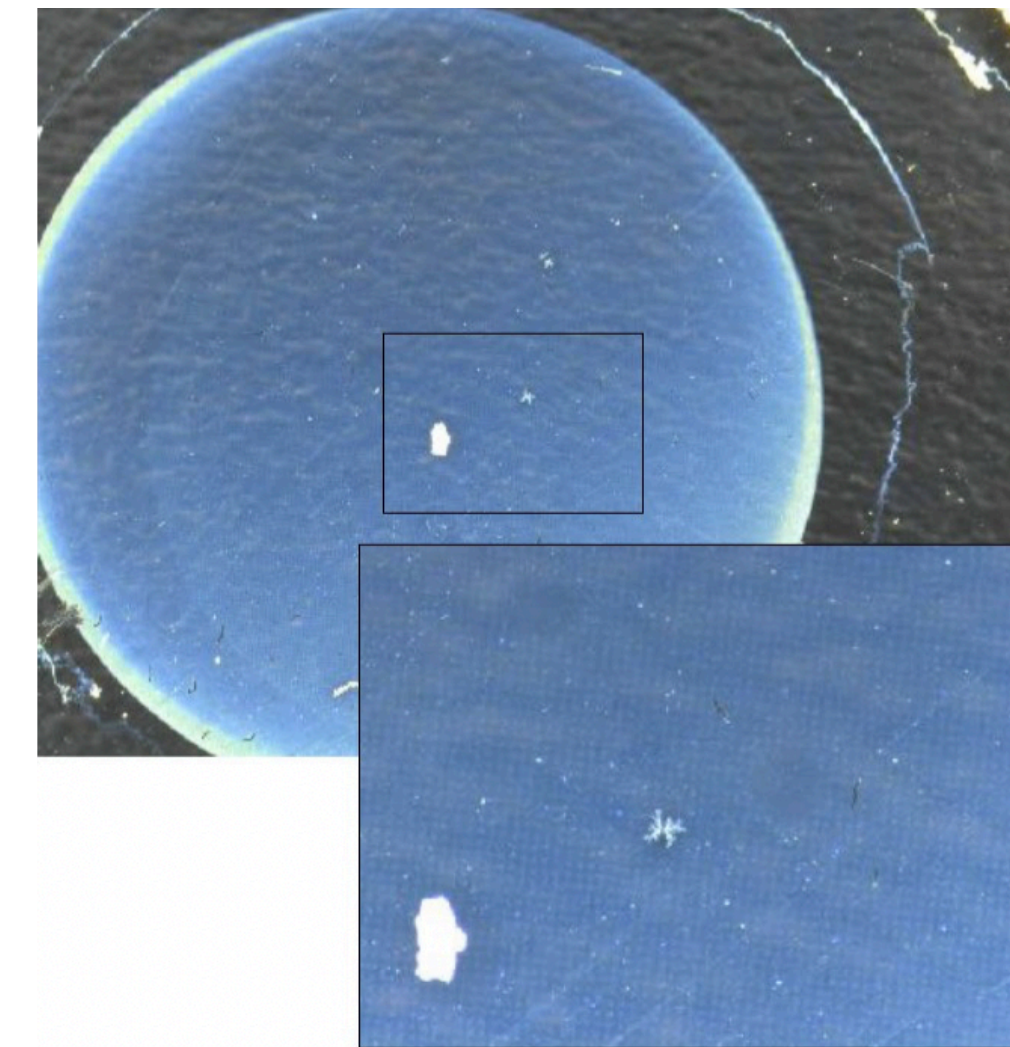

Photocathode robustness

Protection and alternatives

Robustness of photocathode is important to preserve QE and thus detector efficiency and timing resolution during prolonged operation. This may be address in two ways:

Making CsI more robust

Protection layers (MgF₂, LiF, ...)

Minimise effect of ion back flow while preserving high QE

Alternative photocathodes

Metallic, DLC, B₄C, nano diamond powder, CVD diamond, ...

Inherently robust materials with lower QE

Photocathode studies

Dedicated setups to study photocathode QE and possibility to quantify degradation under ion bombardment

Several materials and approaches being studied

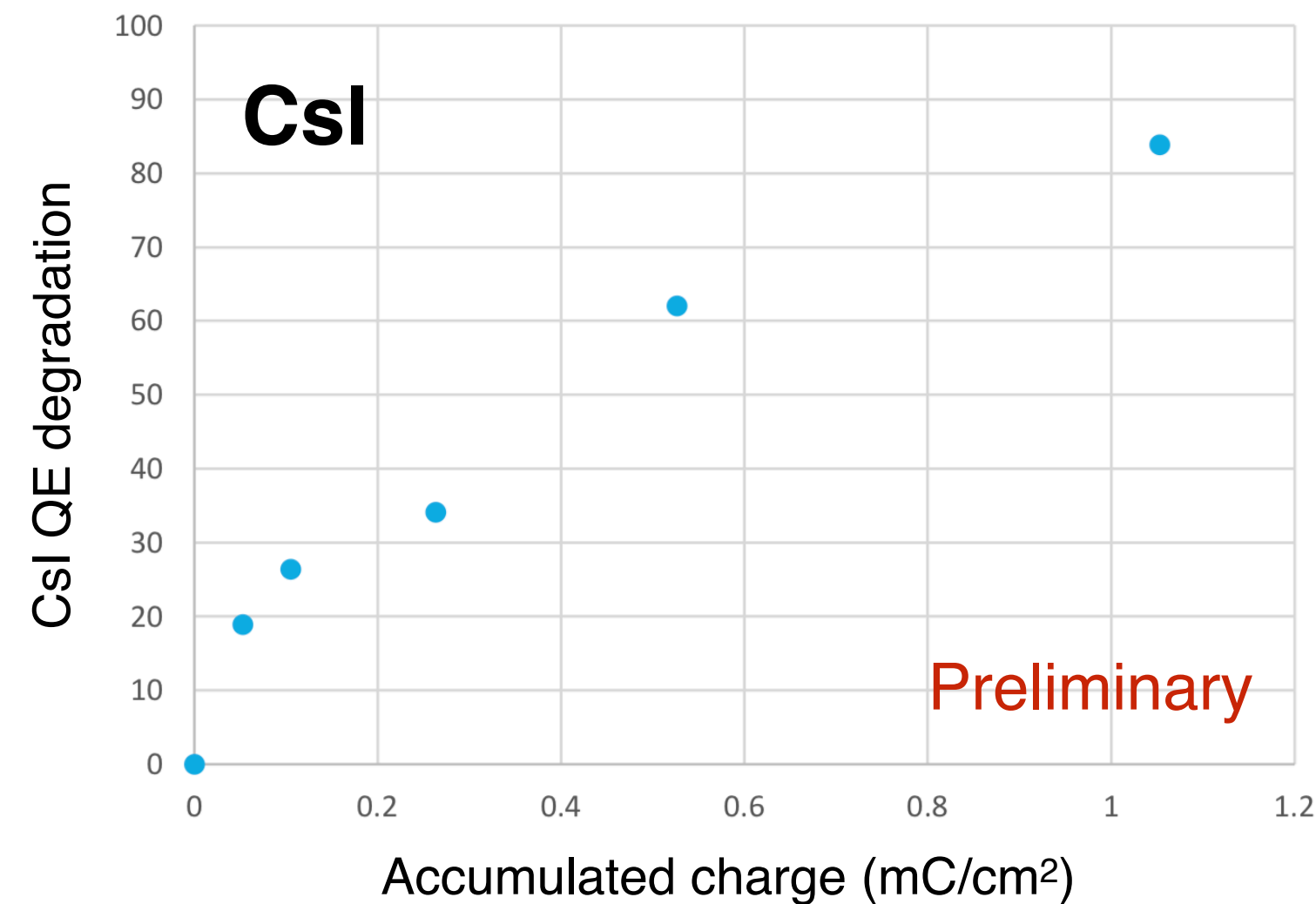
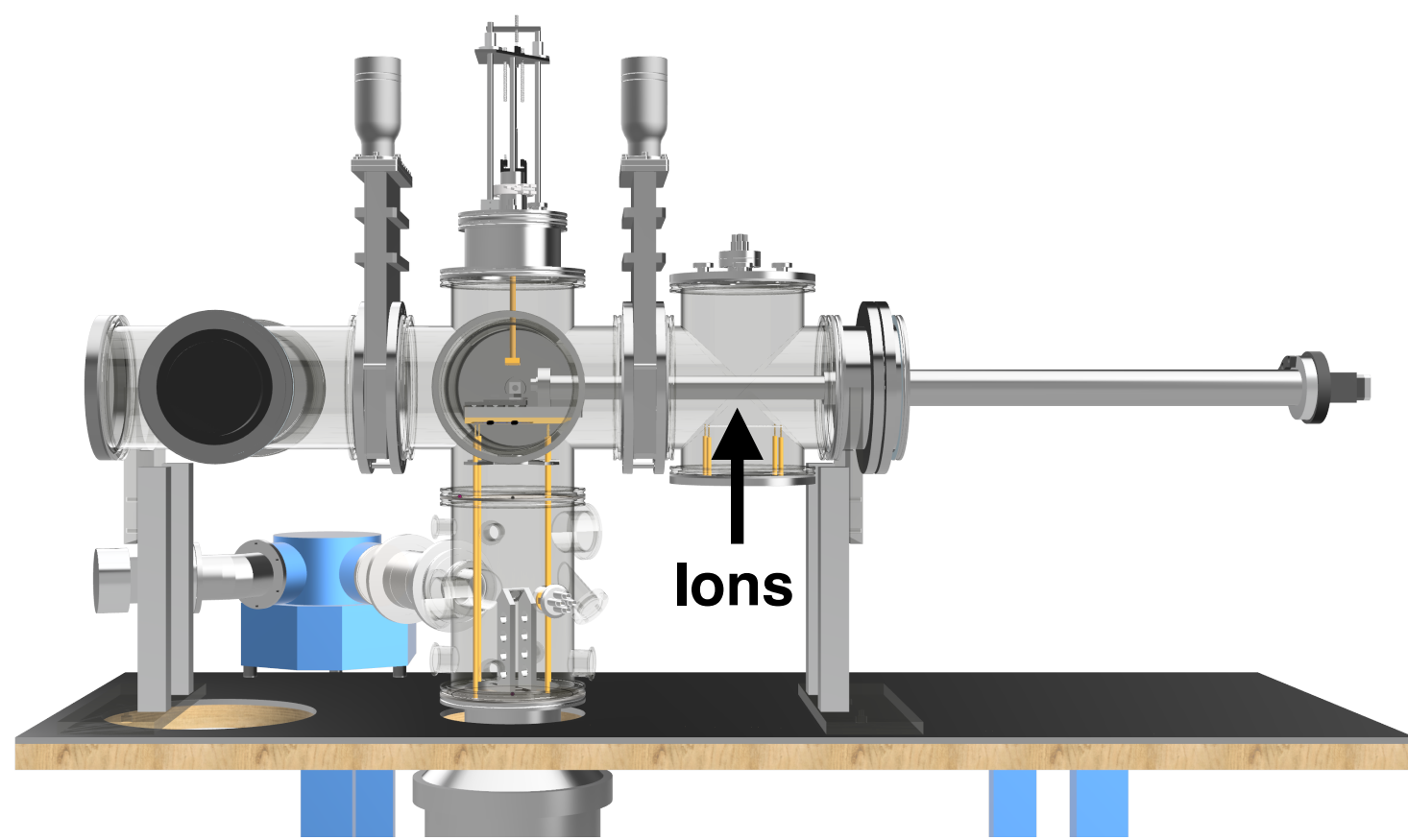

M. Lisowska, ASSET - Photocathode characterisation device, RD51 Mini-Week February 2020, <https://indico.cern.ch/event/872501/contributions/3726017>

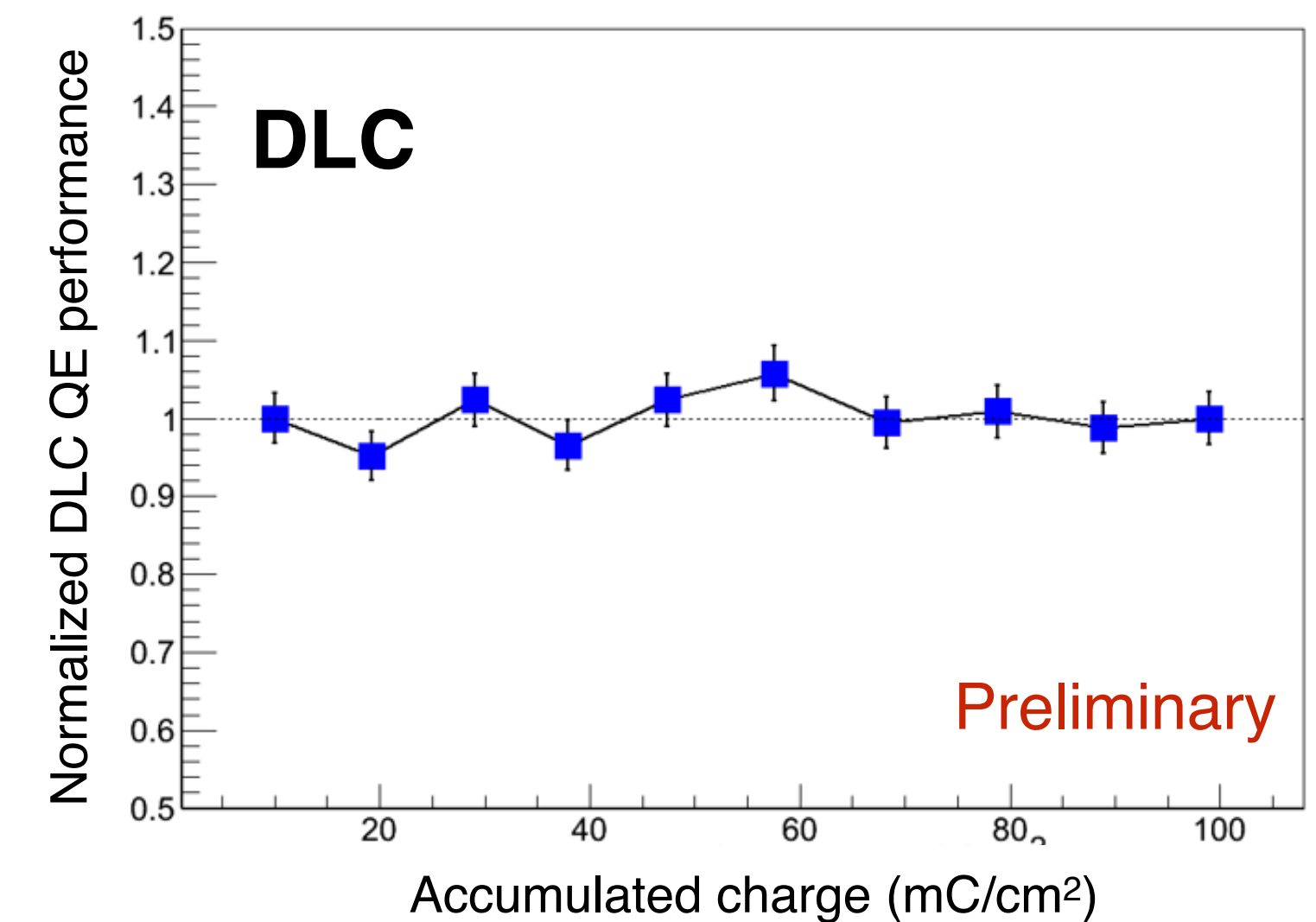

X. Wang, Recent photocathode and sensor developments for the PICOSEC Micromegas detector, MPGD 2019 <https://indico.cern.ch/event/757322/contributions/3387110>

Photocathodes: DLC

Diamond-like carbon (DLC) is a robust material which may also be used as photocathode.

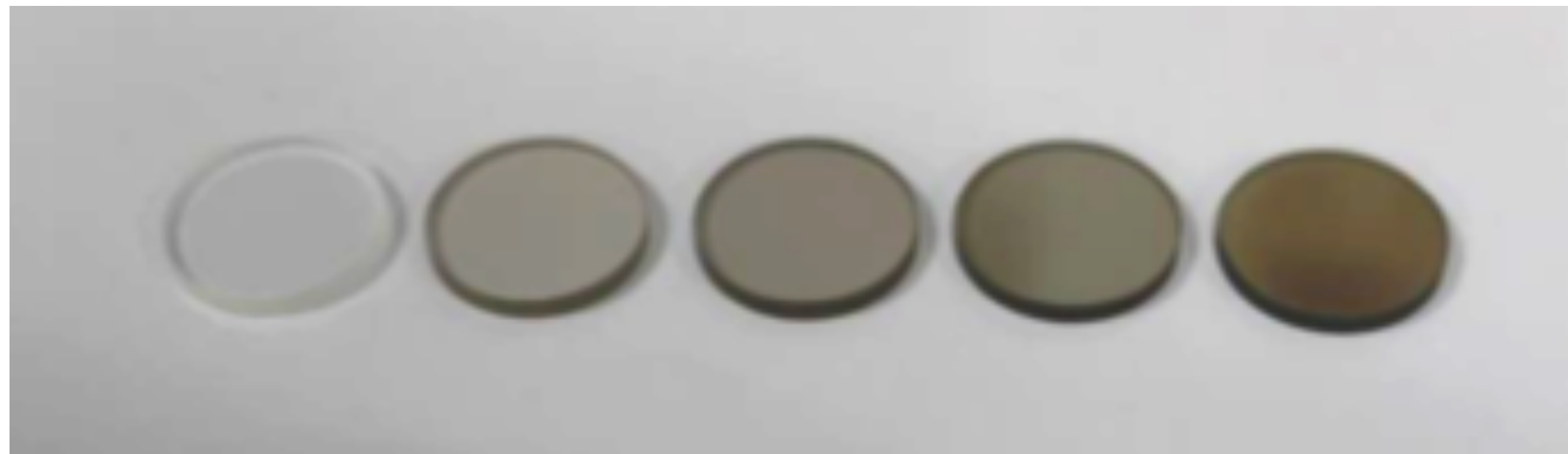
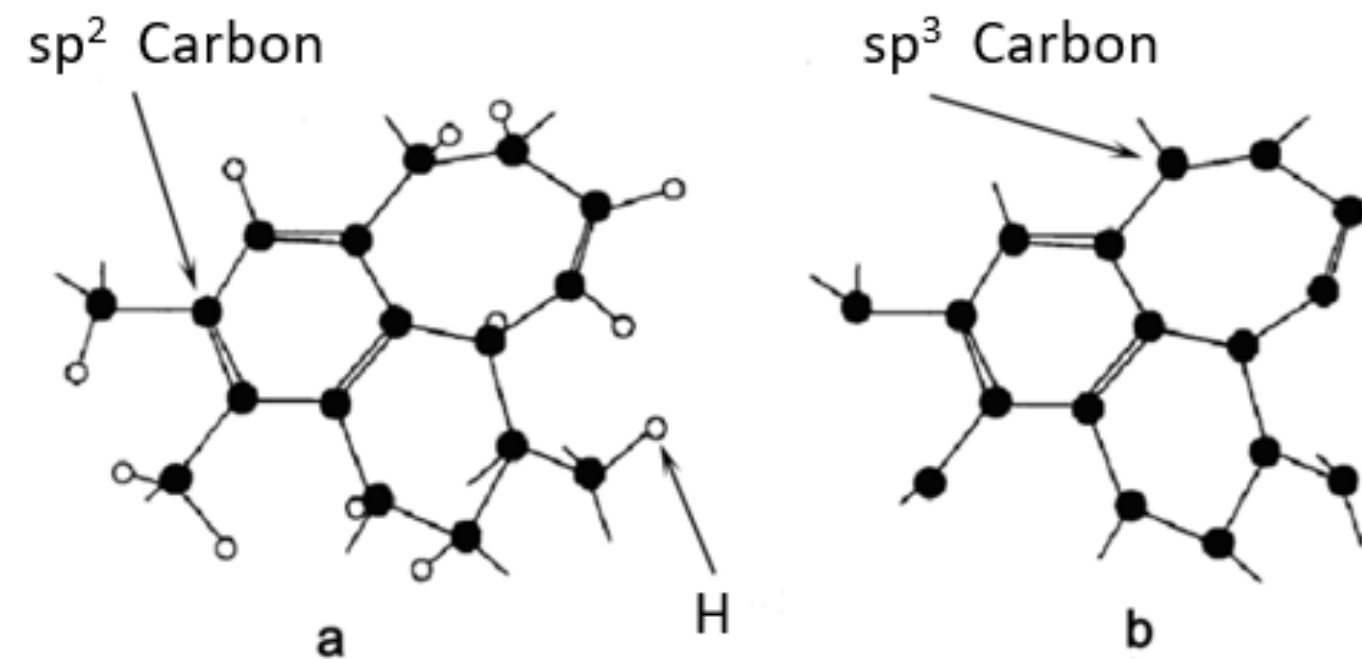

First beam tests show ≈ 3.5 pe/muon and 40-45 ps achievable time resolution

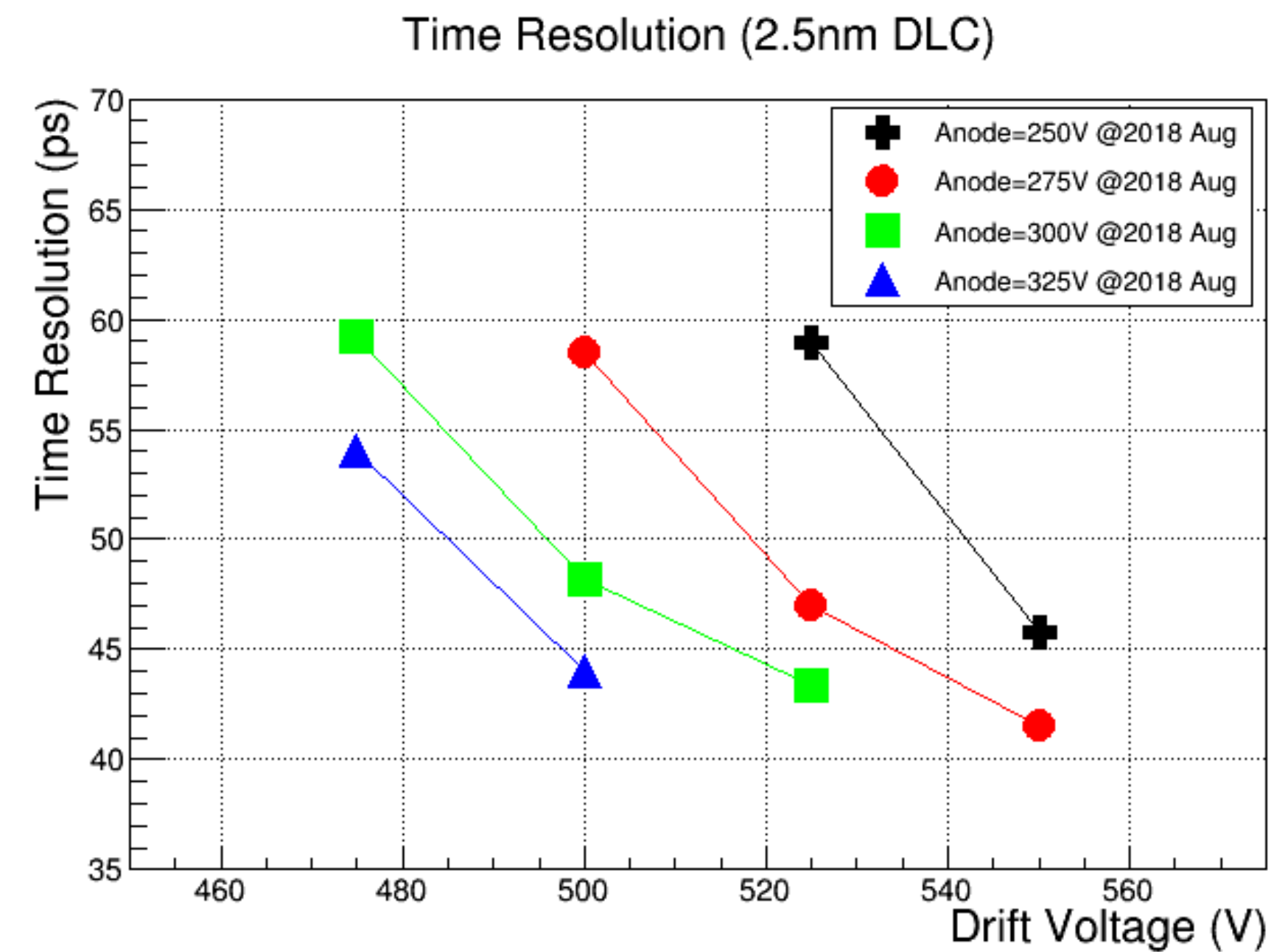

<https://indico.cern.ch/event/709670/contributions/3020862/attachments/1672921/2684467/>

Large-area coverage

Scaling up multi-channel PICOSEC

1 cm diameter PICOSEC prototype was used for laser studies and in test beam campaigns

Simple, single-channel readout

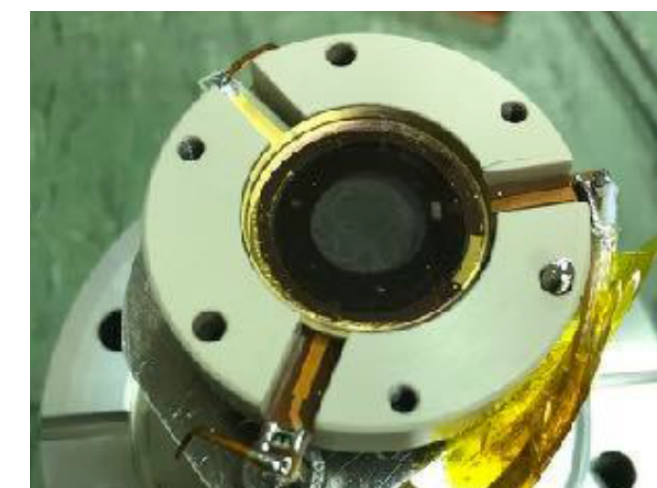
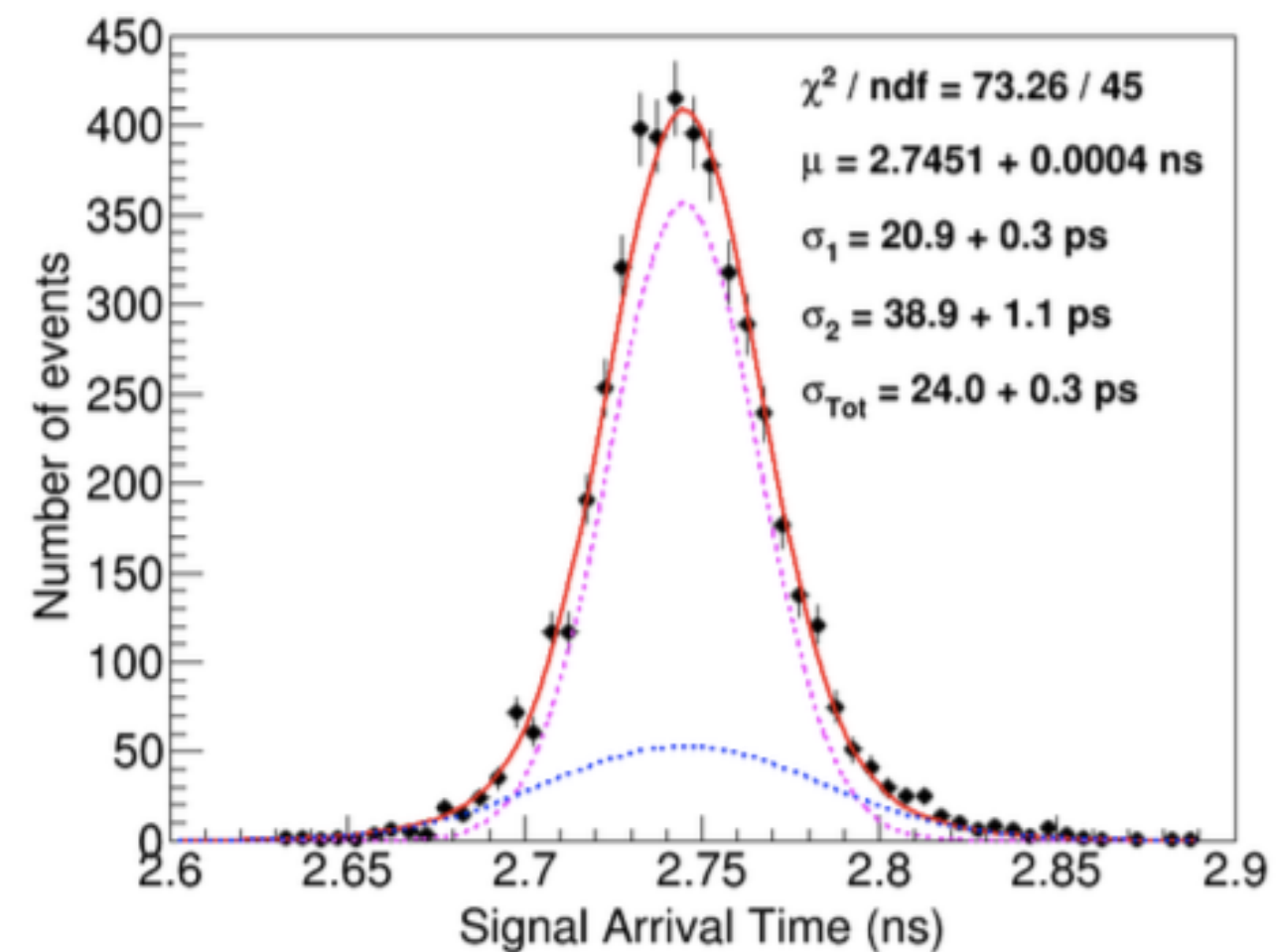
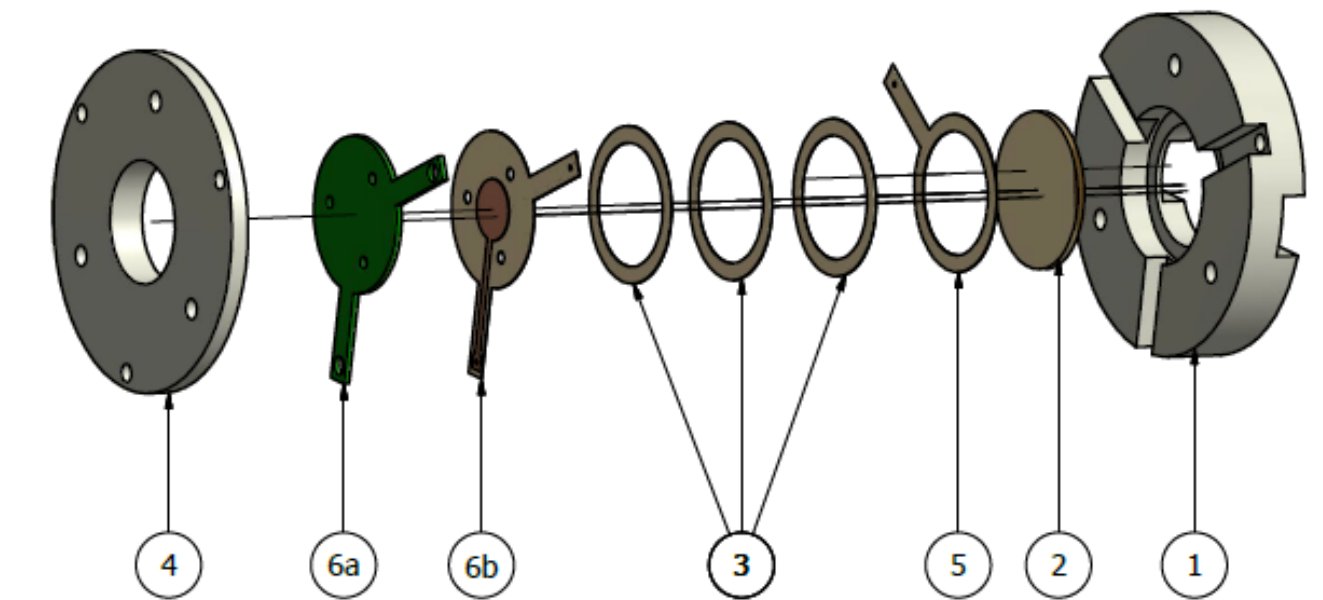
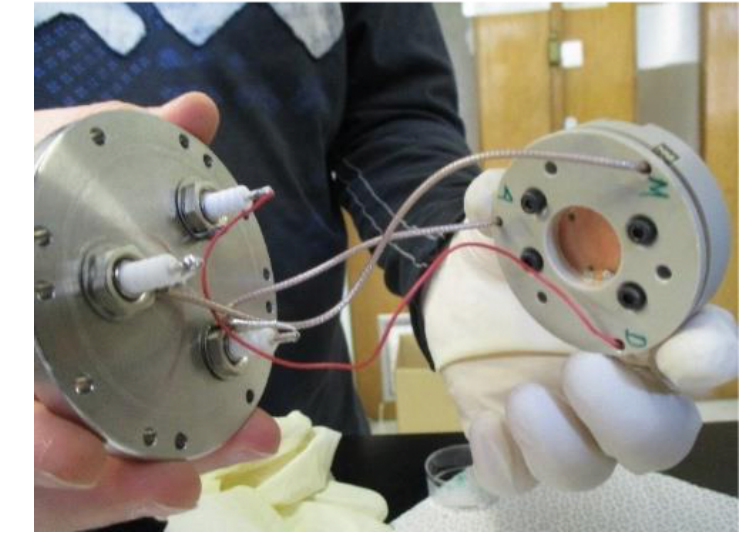

Single pad (2016)
ø1 cm



Multi pad (2017)
ø 1 cm

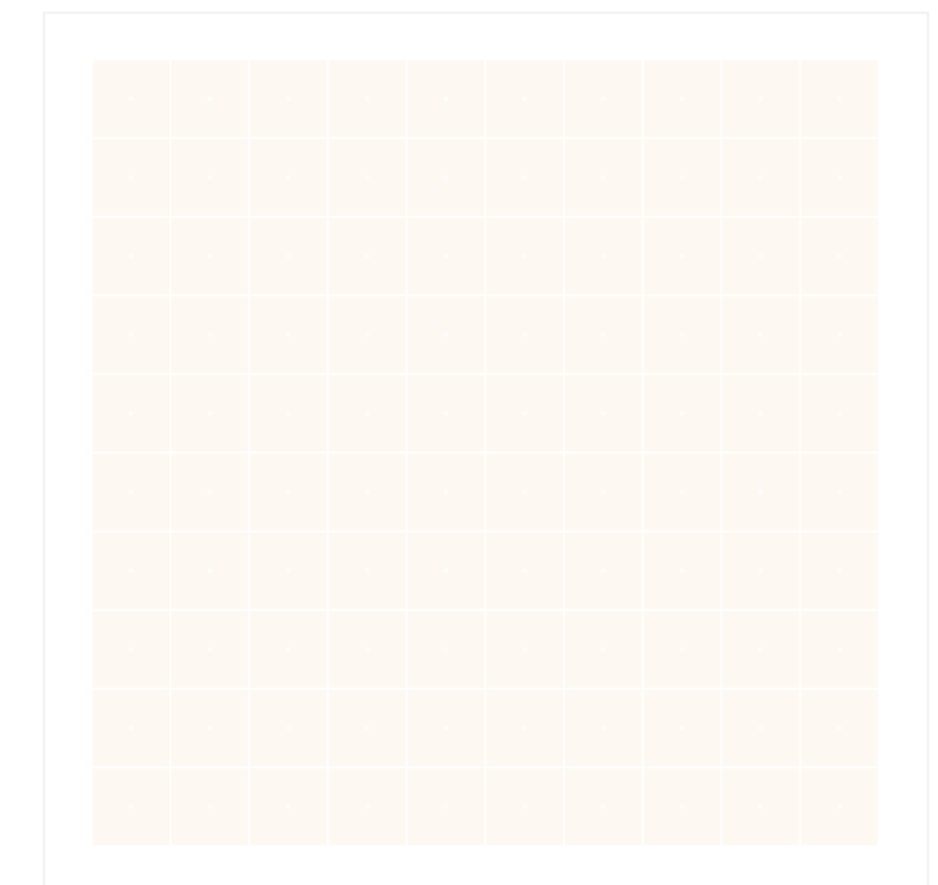

10x10 module
□ 1 cm

Large-area coverage

Scaling up multi-channel PICOSEC

Multi-pad prototype was evaluated in test beam campaigns and timing resolution for signal shared across multiple pads was studied

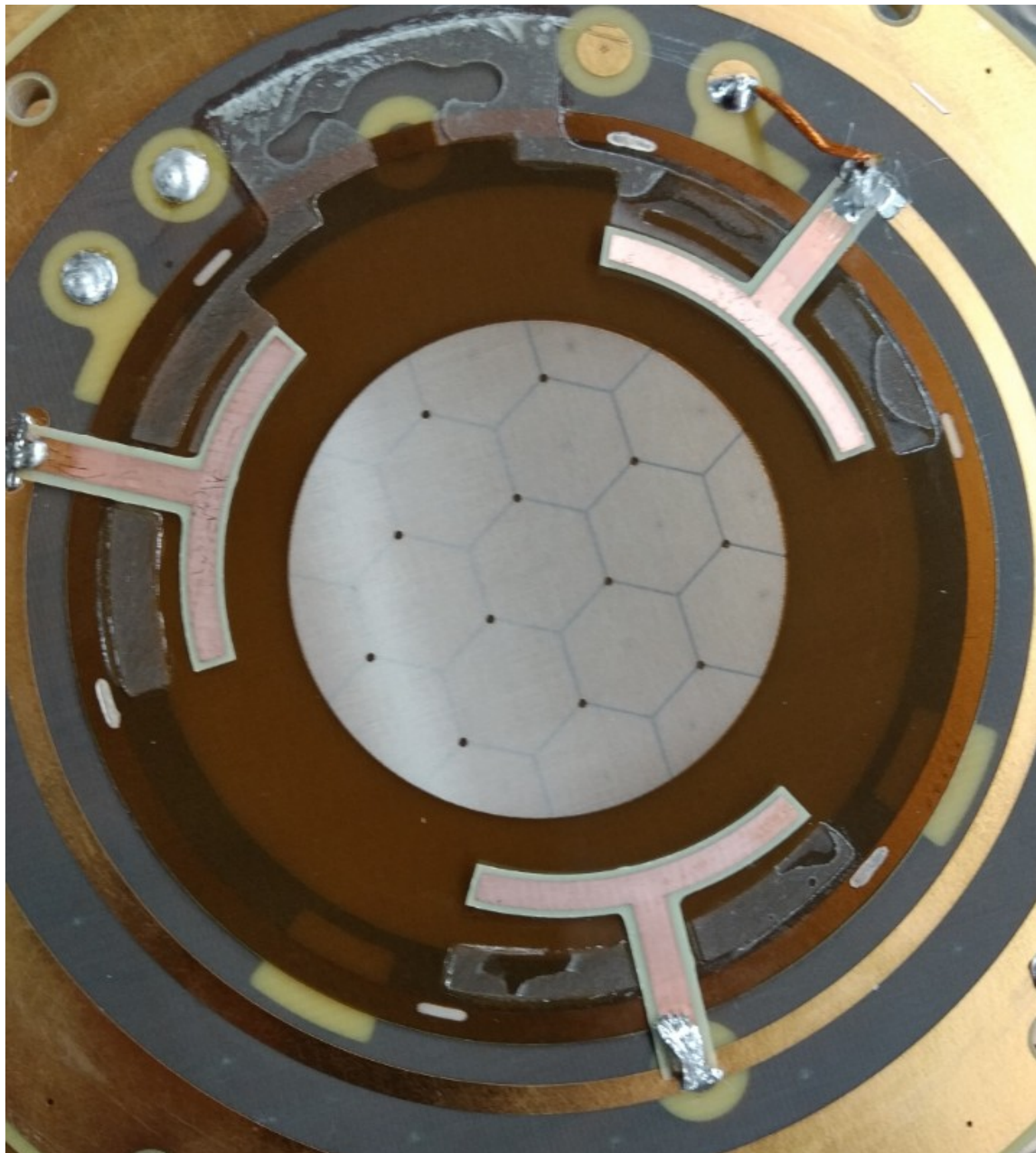

Single pad (2016)
ø1 cm

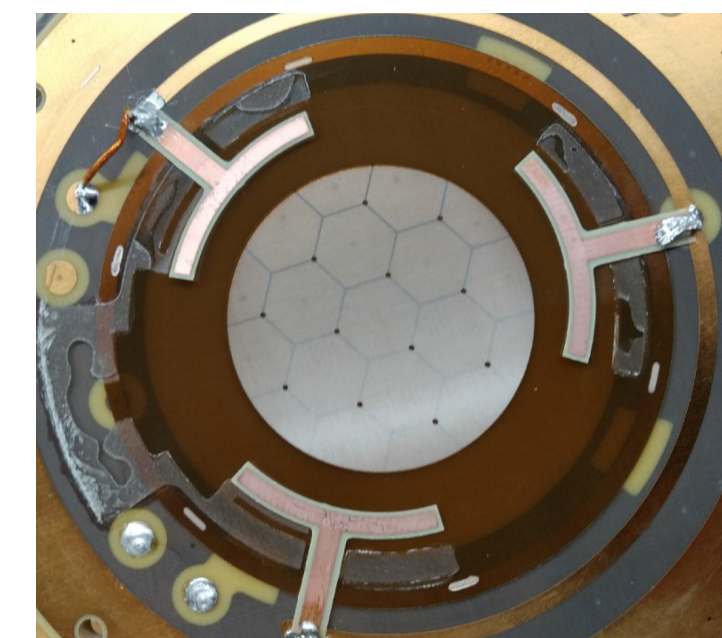

Multi pad (2017)
⬡ 1 cm

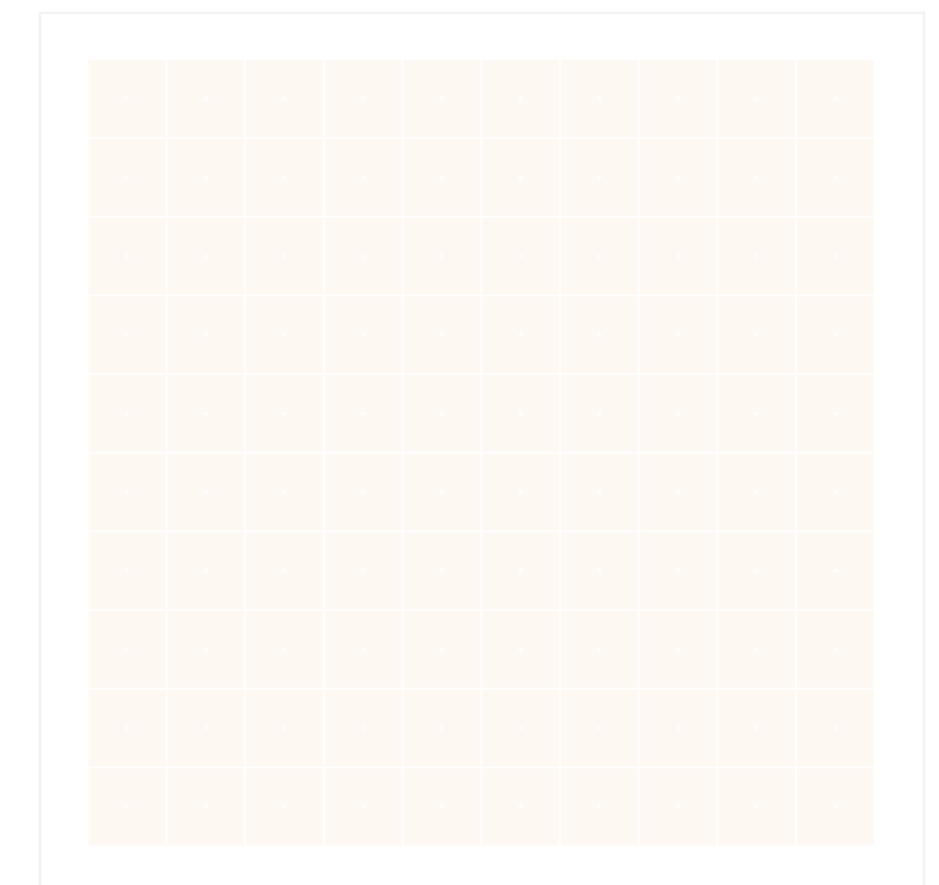

10x10 module
□ 1 cm

Large-area coverage

Scaling up multi-channel PICOSEC

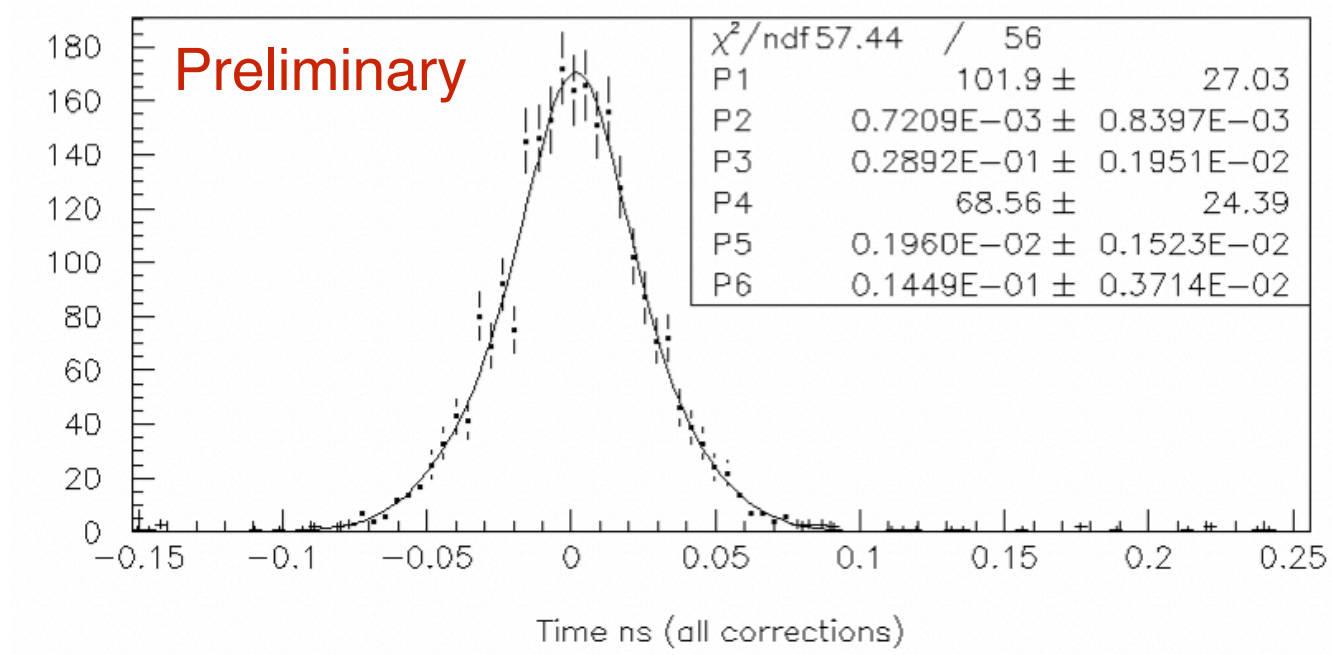
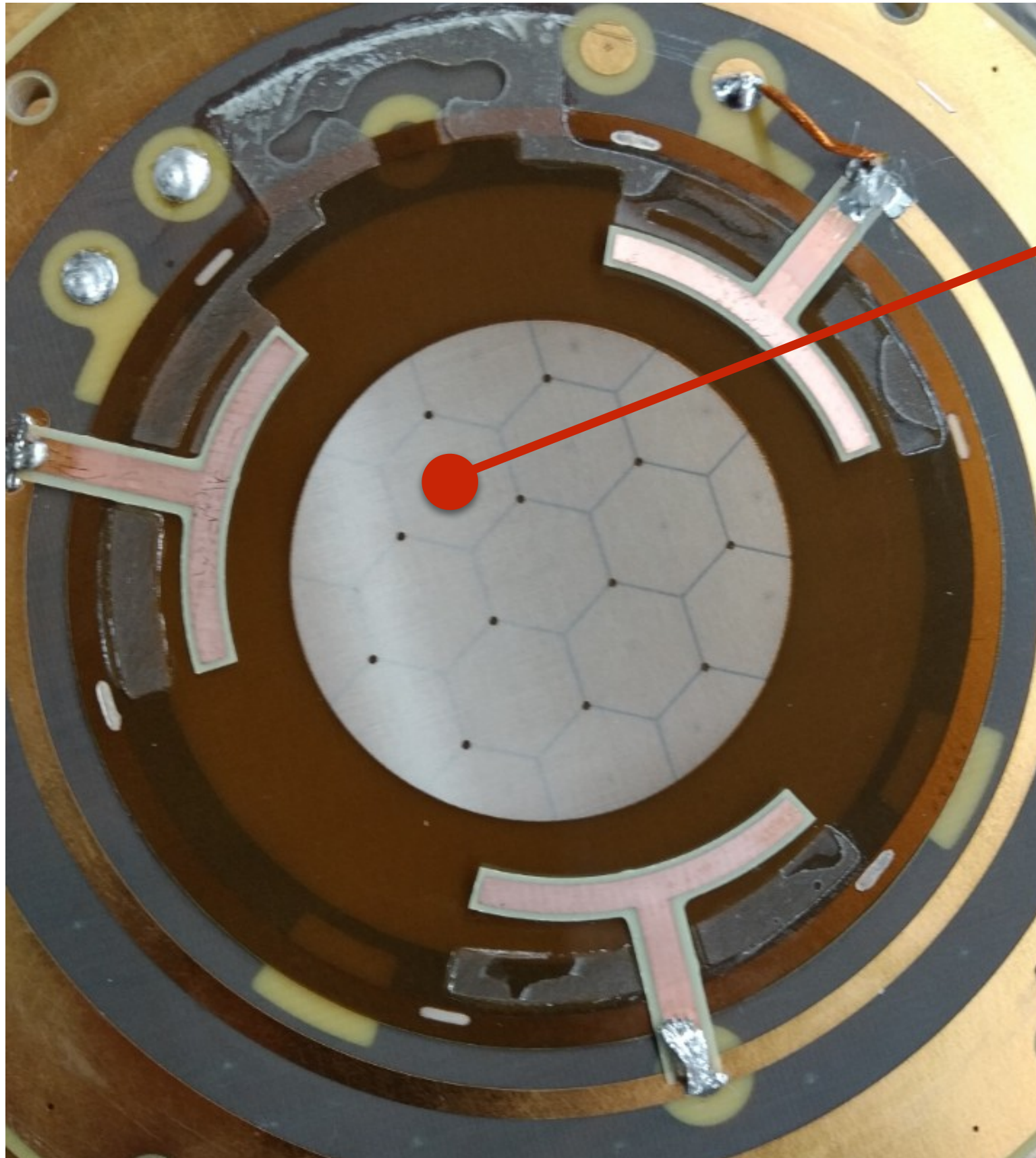

Single pad hit:
25 ps timing resolution for all pads

Large-area coverage

Scaling up multi-channel PICOSEC

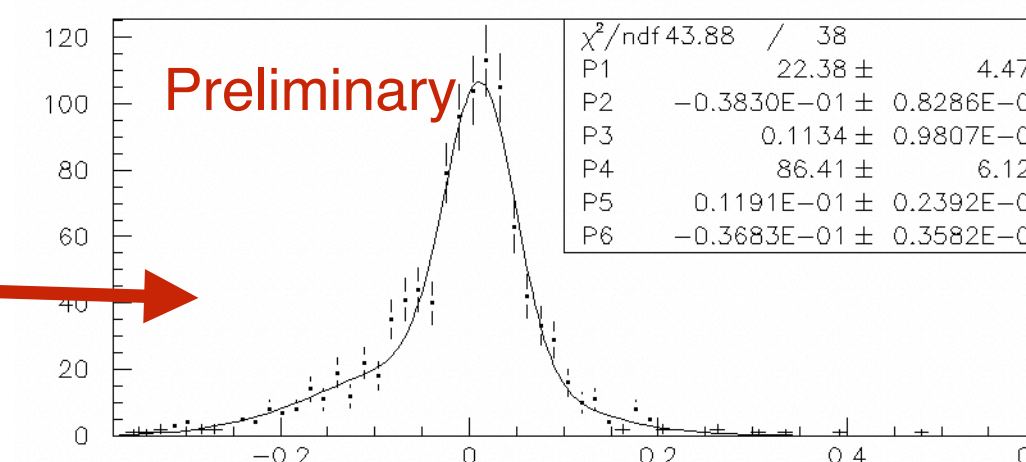
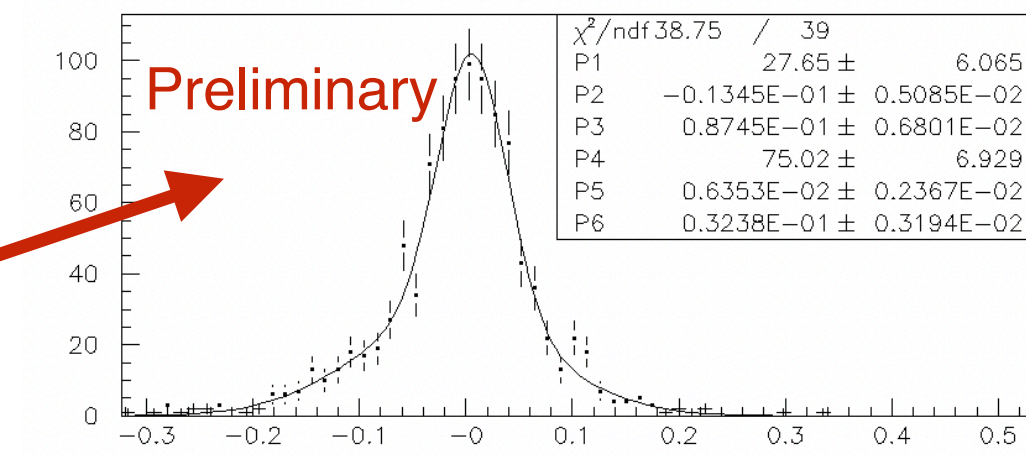
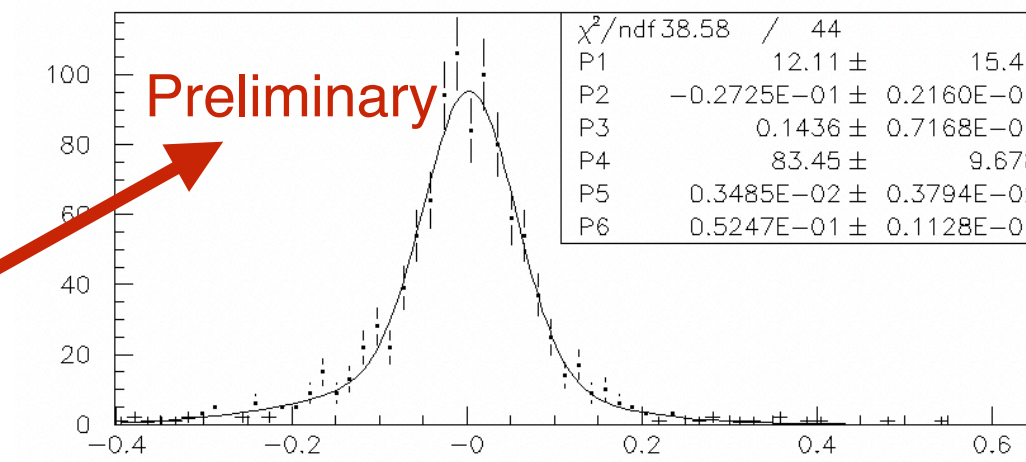
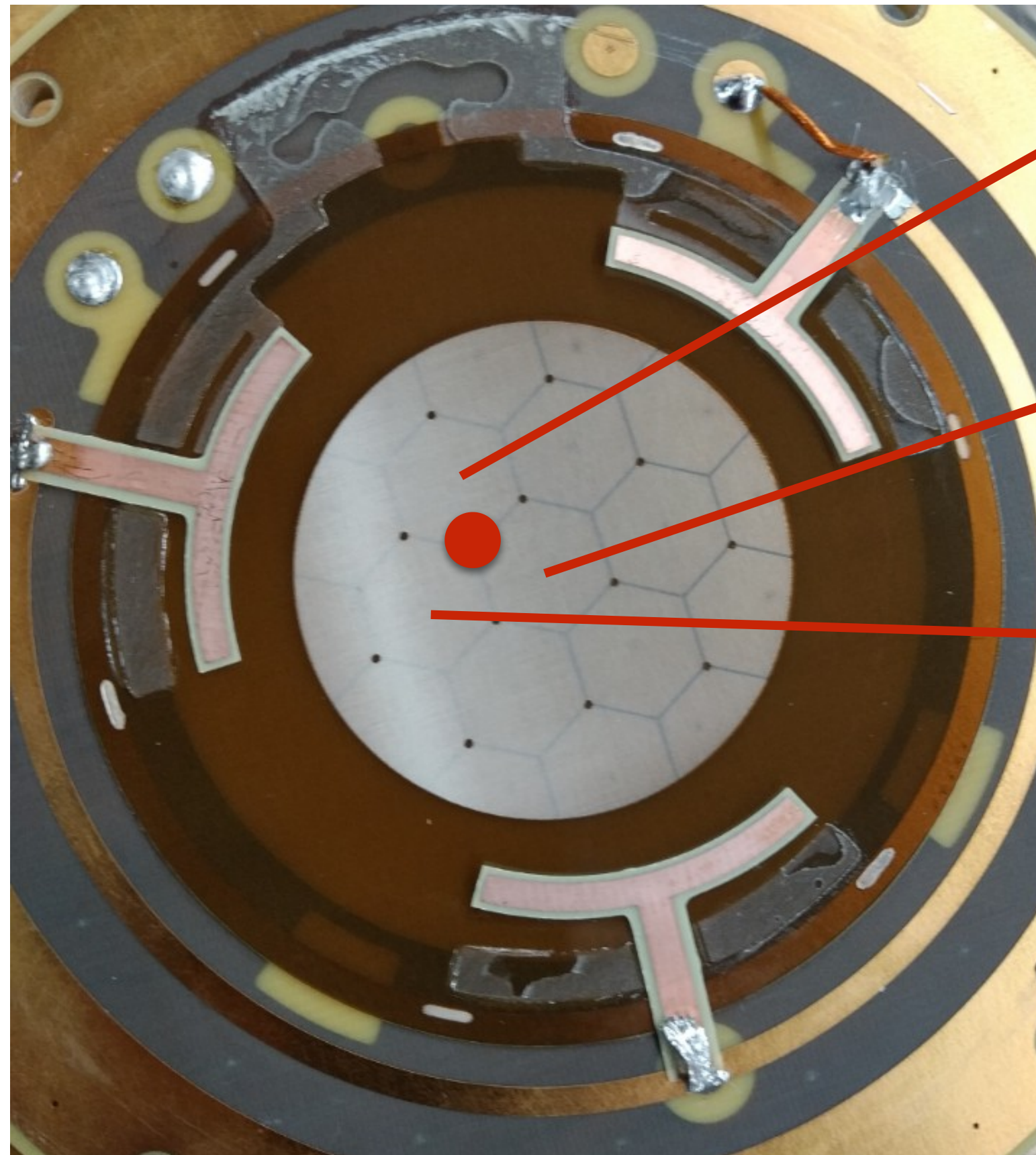

Multiple pads hit:

70 ps / 86 ps / 81 ps timing resolution

Combined: 31 ps timing resolution

Large-area coverage

Scaling up multi-channel PICOSEC

Several variants of multi-channel PICOSEC prototypes in development / under test

Addressing challenges associated with scaling to larger areas:

- Signal routing and sharing across pads
- Multi-channel amplifiers and digitisers
- Resistive multi-pad anode
- Detector uniformity
- Large Cherenkov radiators
- Mechanics to preserve precise gaps
- Compact detector vessel
- ...

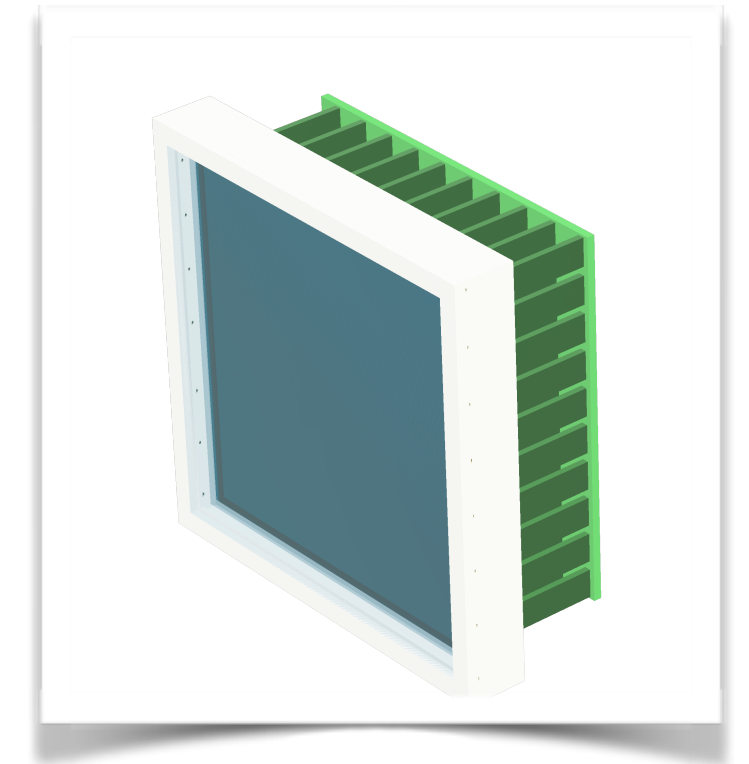
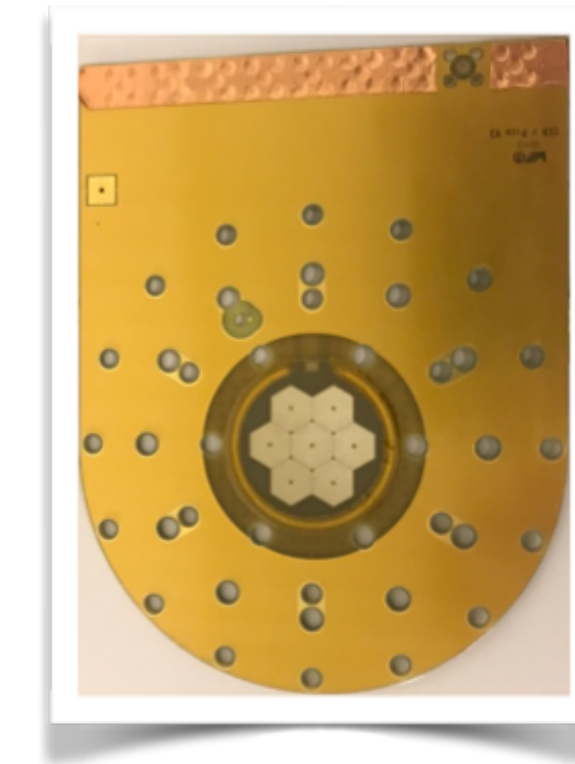

Single pad (2016)
ø1 cm



Multi pad (2017)
ø1 cm

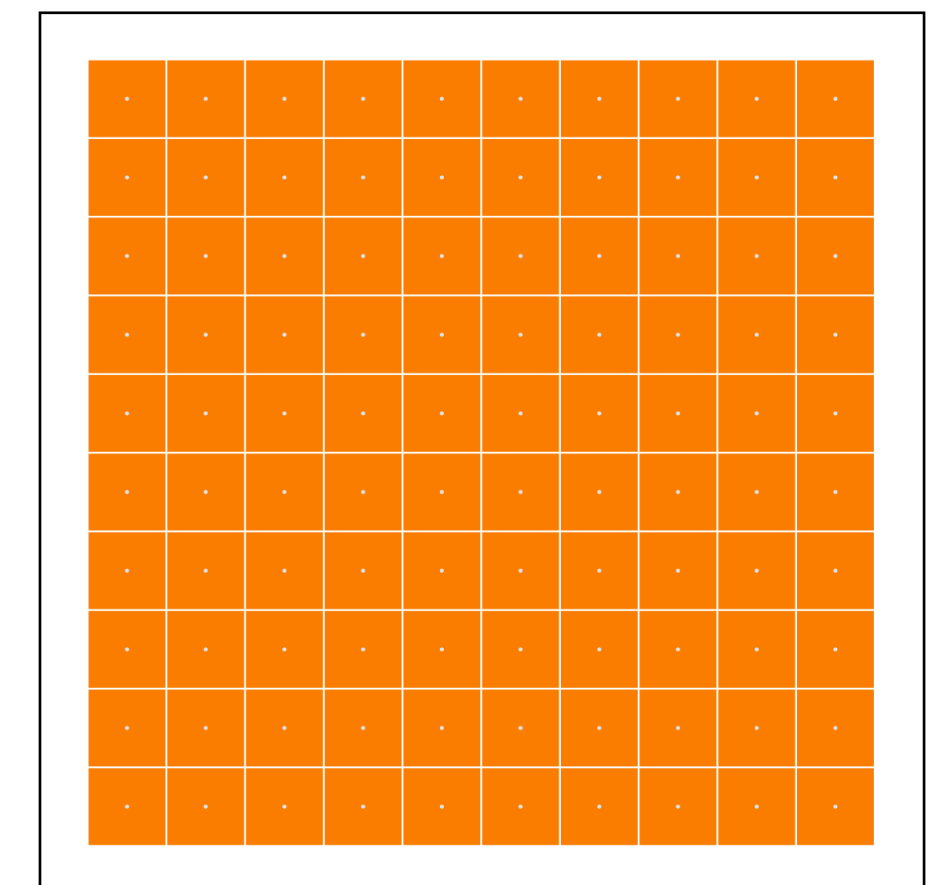

10x10 module
□ 1 cm

Summary

The PICOSEC detection concept achieves high timing precision of up to 24 ps for MIPs.

Beam tests (muons, pions) and laser tests (single-electron response) have been conducted to systematically study and optimise the detector performance.

Detailed **detector response simulations** provide an in-depth understanding of detector physics and signal formation.

Detector robustness, photocathodes and large-area coverage are pursued towards a robust, larger-area PICOSEC precise timing detector.

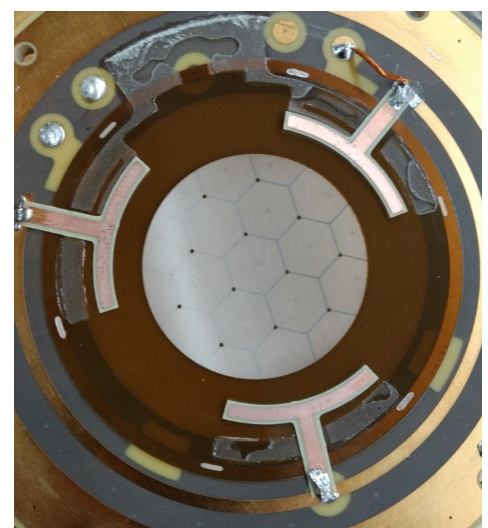
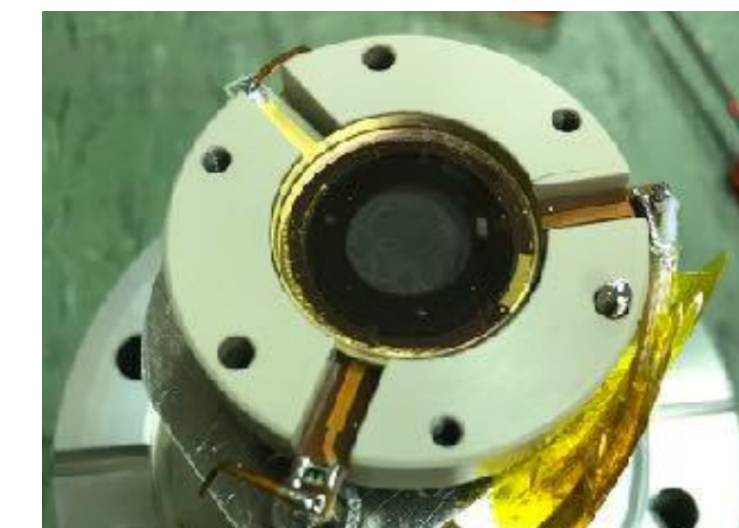
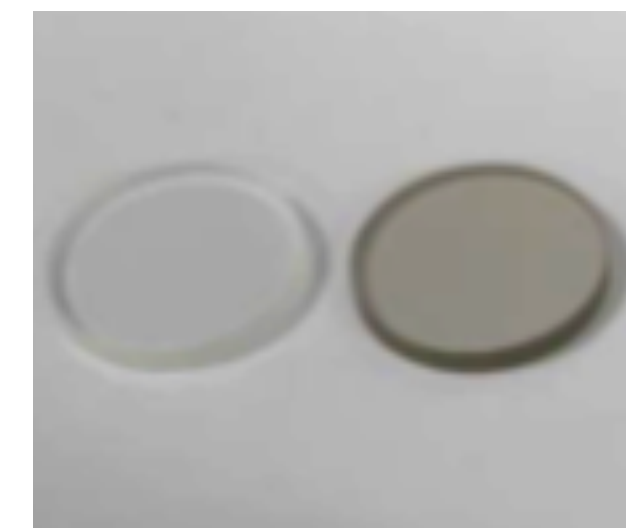
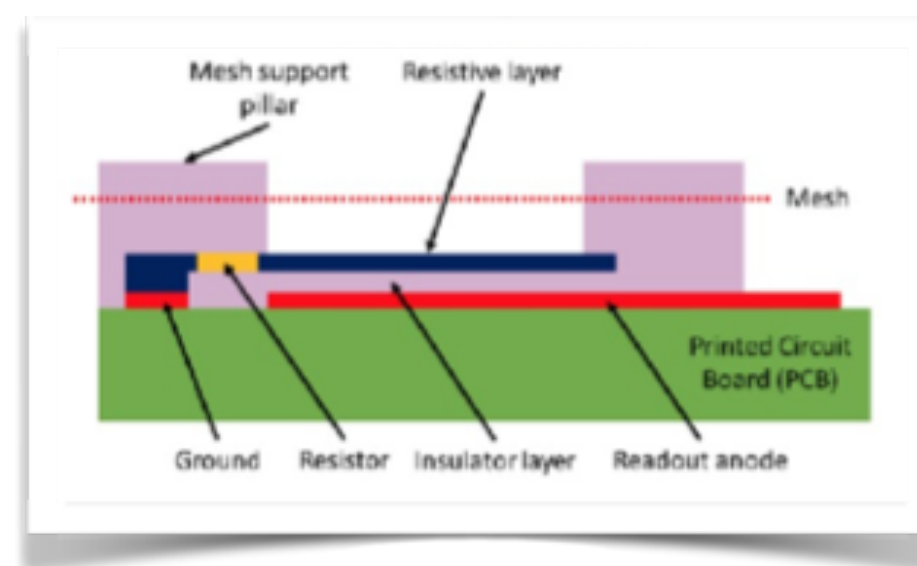
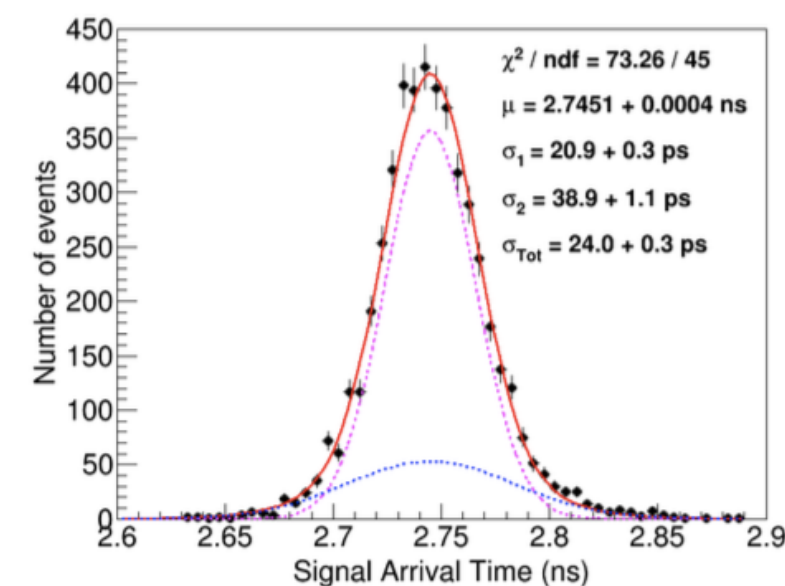
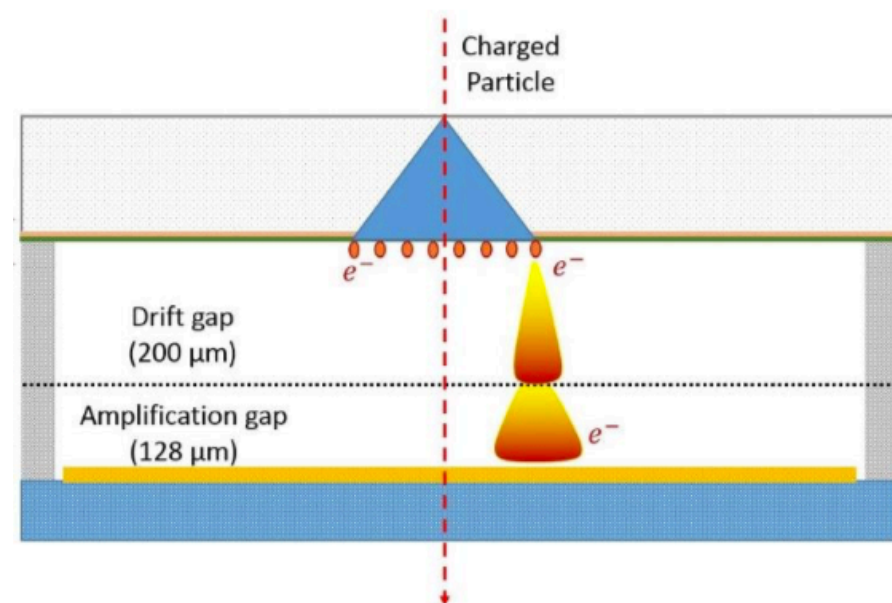

Backup

Combining multi-pad hits

$$\chi^2 = \sum_{i=1,4} \frac{\left(\left[t_i - \{ \langle SAT \rangle (R_i, \theta_i) - \langle SAT \rangle (R_i, 90^\circ) \} - \{ SL(Q) \} - \hat{t} \right] \right)^2}{(Res(Q_i))^2}$$

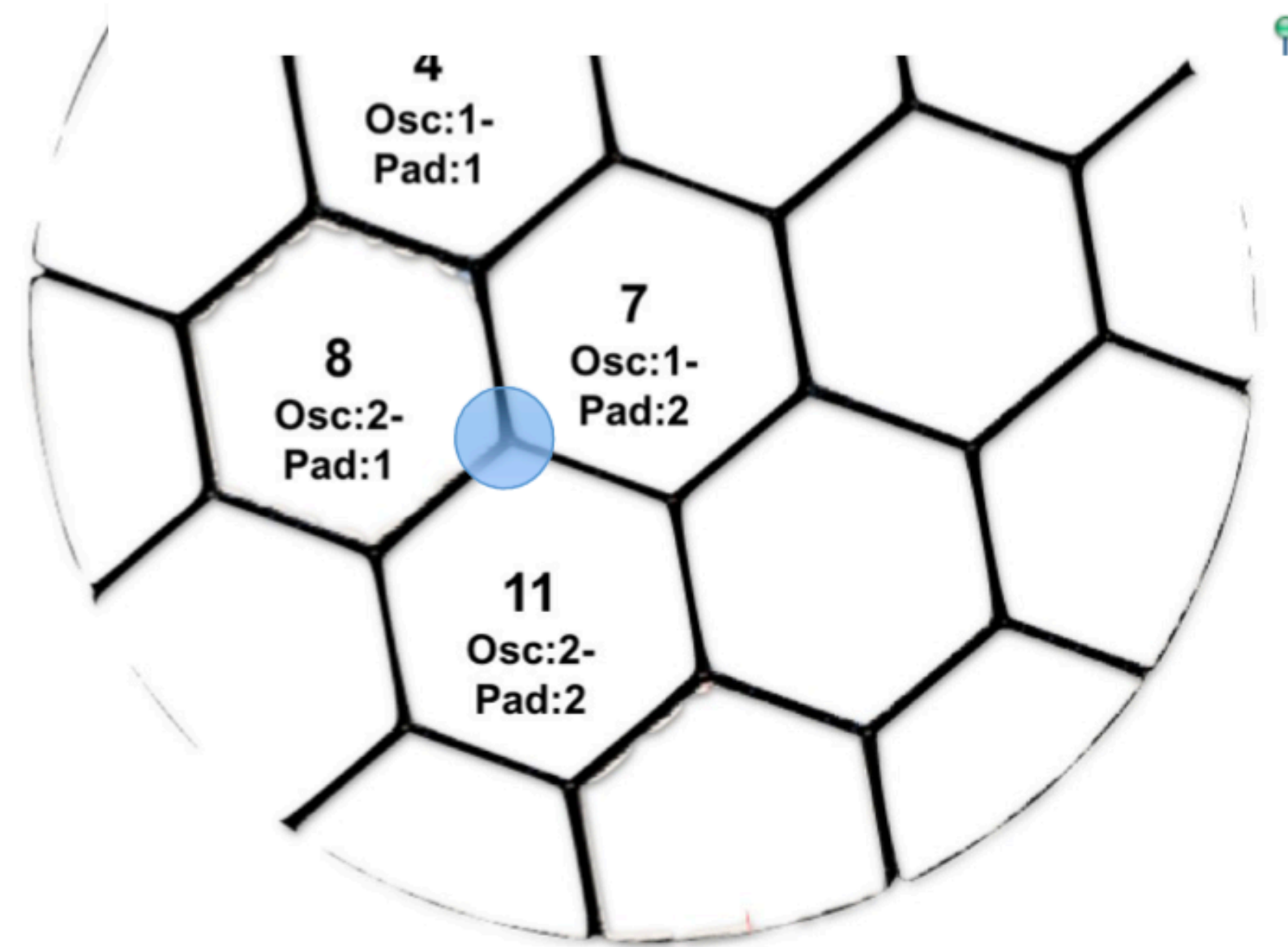

Gas studies

Gas mixture (Neon-Ethane-CF4)	U_{Amp} (V)	U_{Drift} (V)	echarge (pC)	amplitude (mV)	$\sigma_{\text{tres.}}$ (ps)
80-10-10	275	525	8.58 ± 0.13	166.3 ± 0.2	43.89 ± 1.00
89-2-9	255	445	1.69 ± 0.01	31.56 ± 0.44	112.15 ± 4.03
80-20-0	270	470	0.54 ± 0.01	21.61 ± 0.18	129.21 ± 6.03
85-15-0	310	395	0.74 ± 0.01	22.83 ± 0.21	113.48 ± 4.66
90-10-0	340	340	0.82 ± 0.01	20.72 ± 0.09	150.23 ± 3.17
95-5-0	230	375	1.13 ± 0.01	22.98 ± 0.16	181.09 ± 8.91

Multi-pad prototype

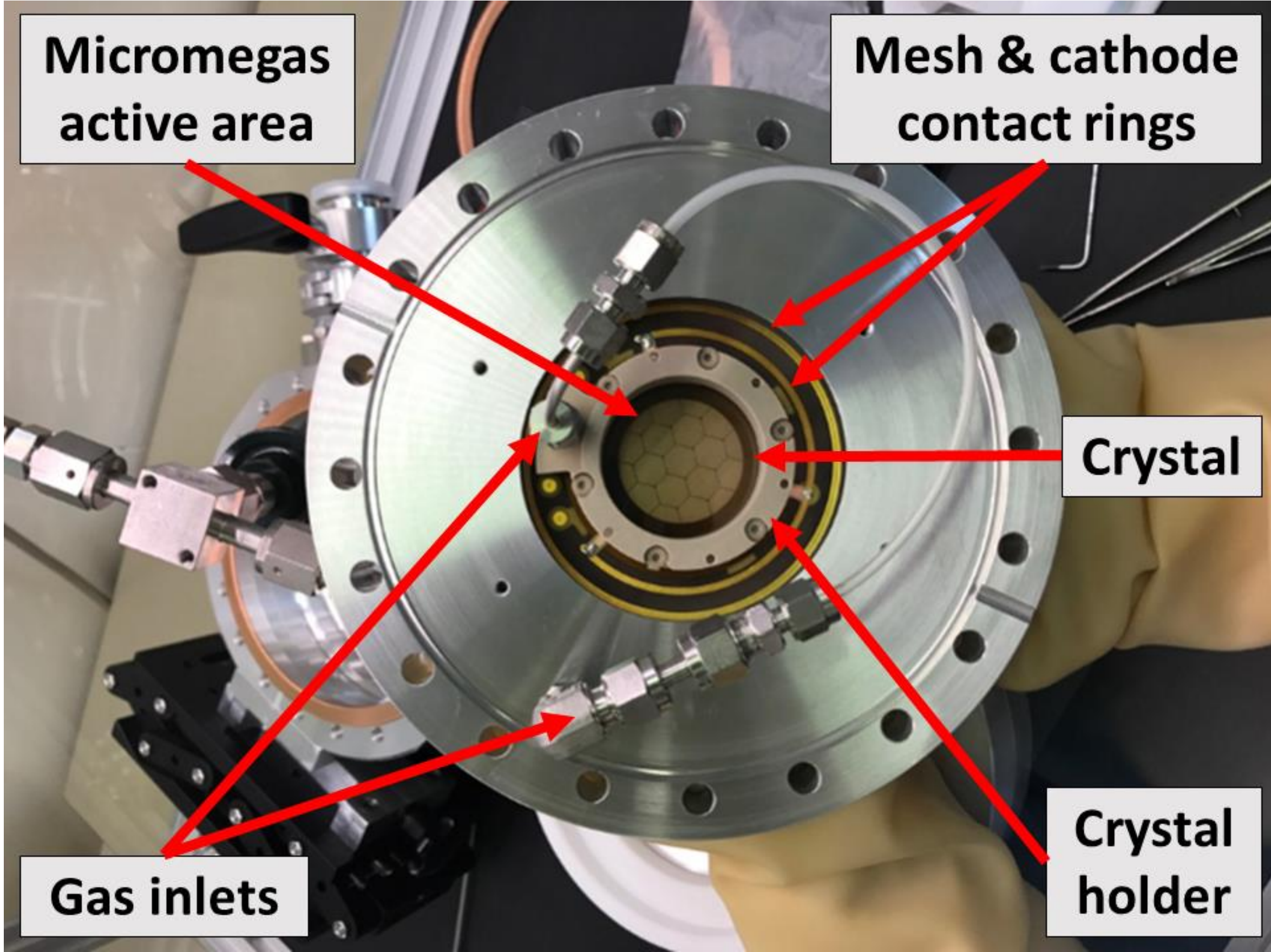
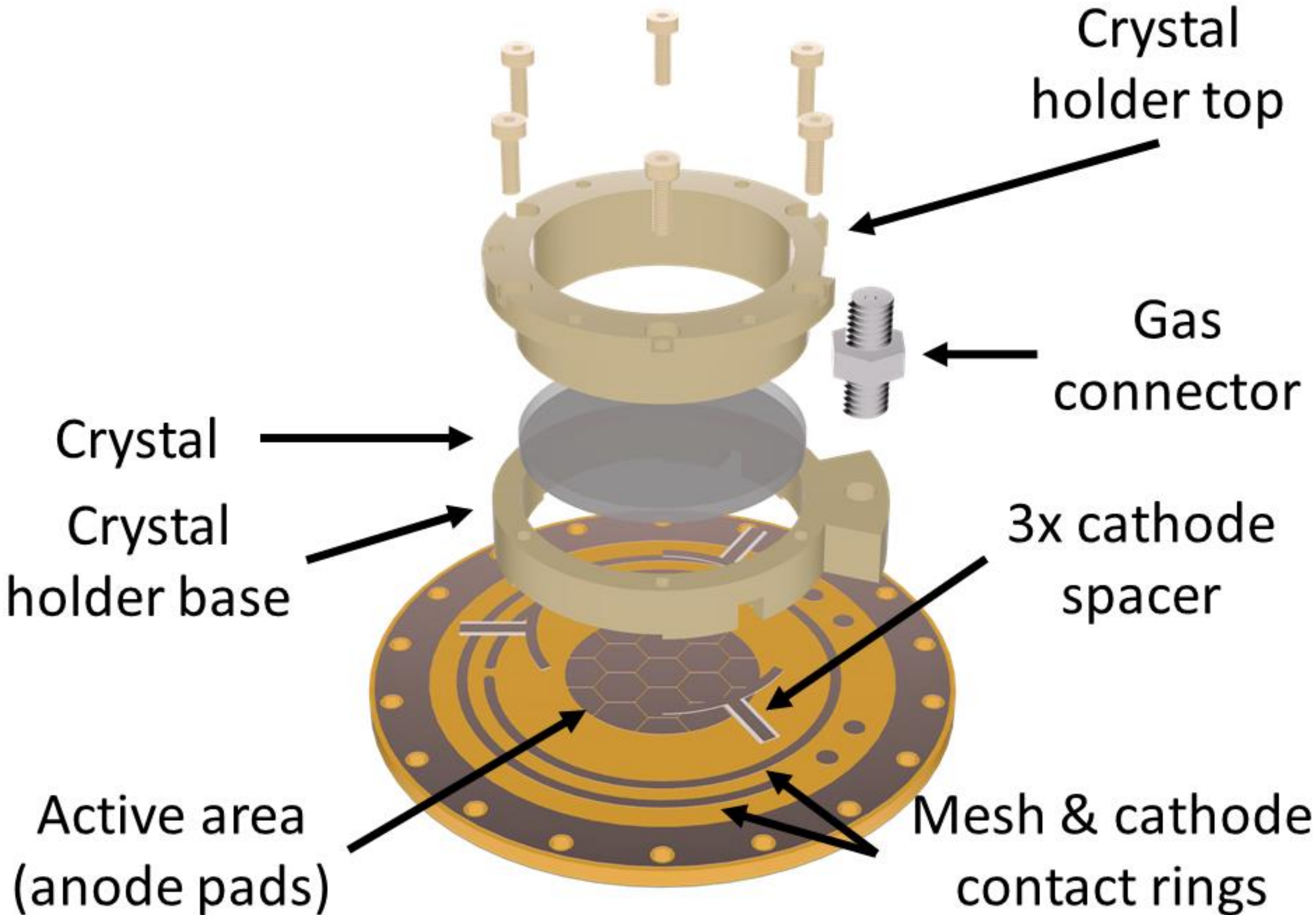

Photocathodes

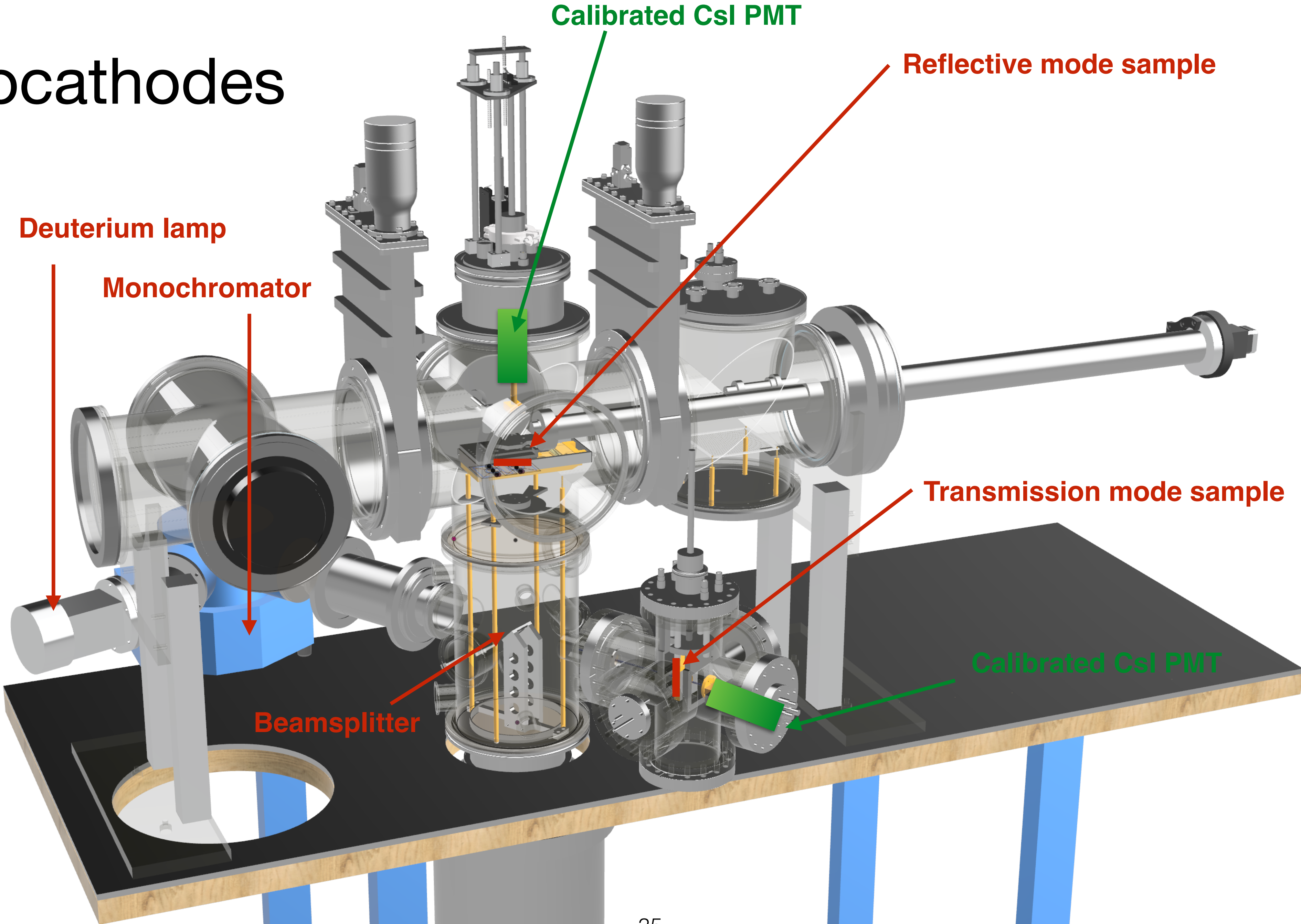

Gas studies

